

FILTERED HIGH DENSITY D SUB CONNECTORS

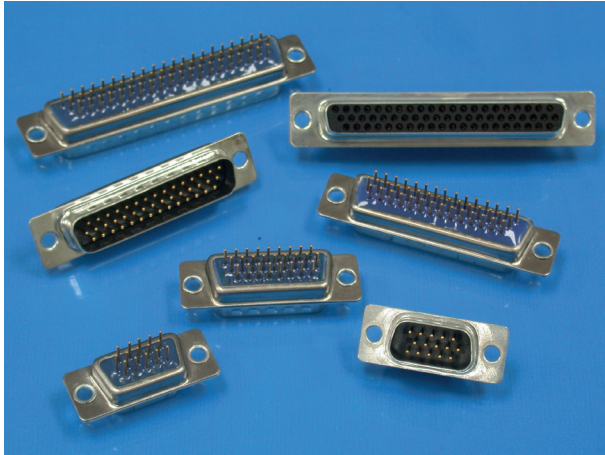

RoHS Compliant
Directive 2002/95/EC

Cinch Filtered High Density Connector offers a higher Contact density to save space but maintains all the benefits of Cinch's high performing Std Filter D Sub Connector range.

Features :

- Cinch High Density Filtered D Sub is a high quality Turned Pin Contact Connector.
- Specially designed for commercial applications where space is critical.
- The encapsulation of filter elements is made with Epoxy for maximum resistance to hazardous environments.
- Cinch High Density Filtered D Sub range have the same size & footprint as the Standard HTD22 D Sub Connectors.
- Accepts Standard Cinch D Sub accessories.
- Compatible to other High Density HTD22 Connectors & variants.
- Bright Tin & Nickel finish shells with grounding indents for EMI / RFI shielding.

Part Numbering

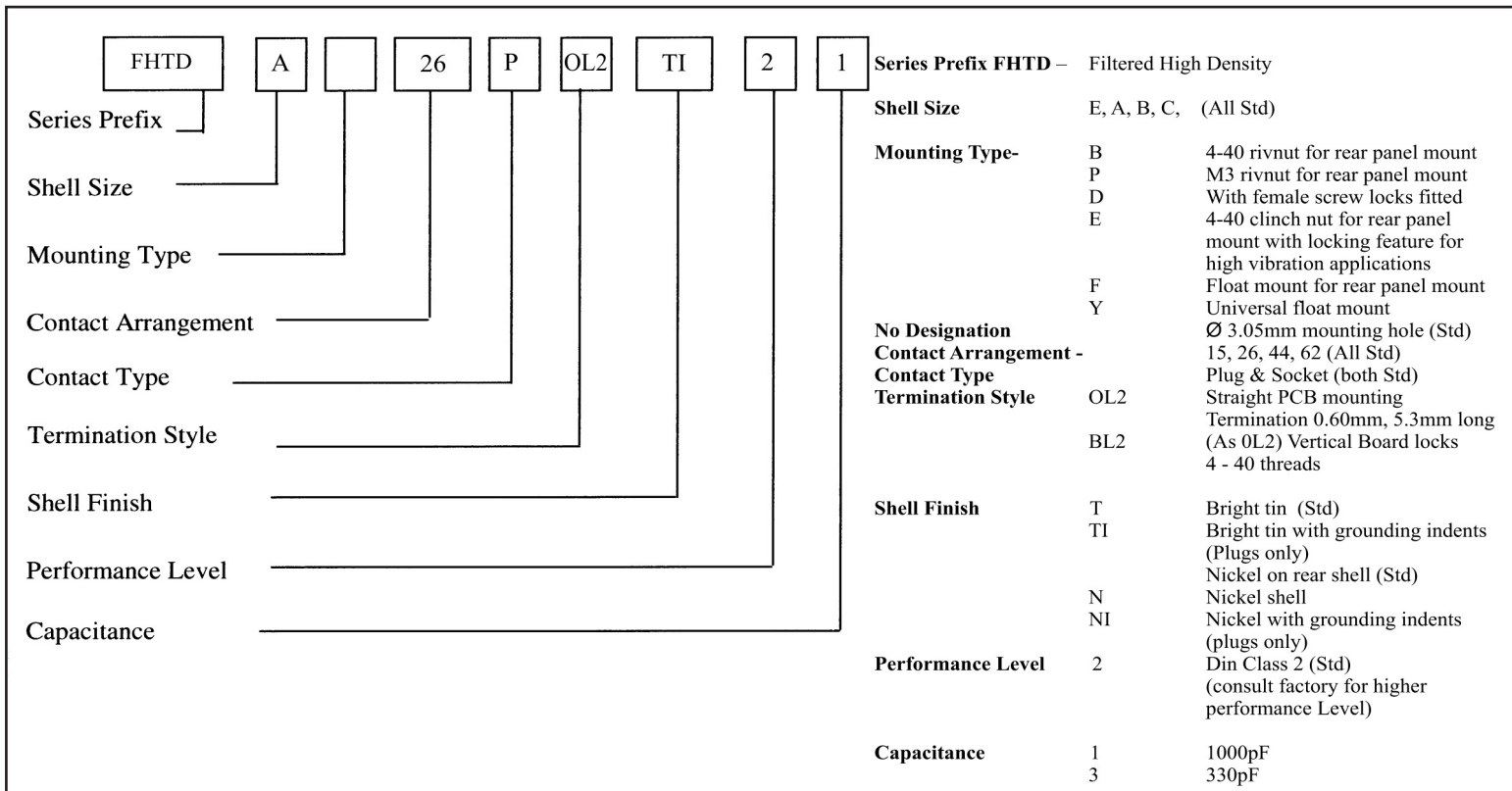

Plating Specification

Performance level	Performance	Comments
2	250 matings minimum followed by 21 day damp heat test & 4 day industrial Atmosphere test.	Meets DIN class 2

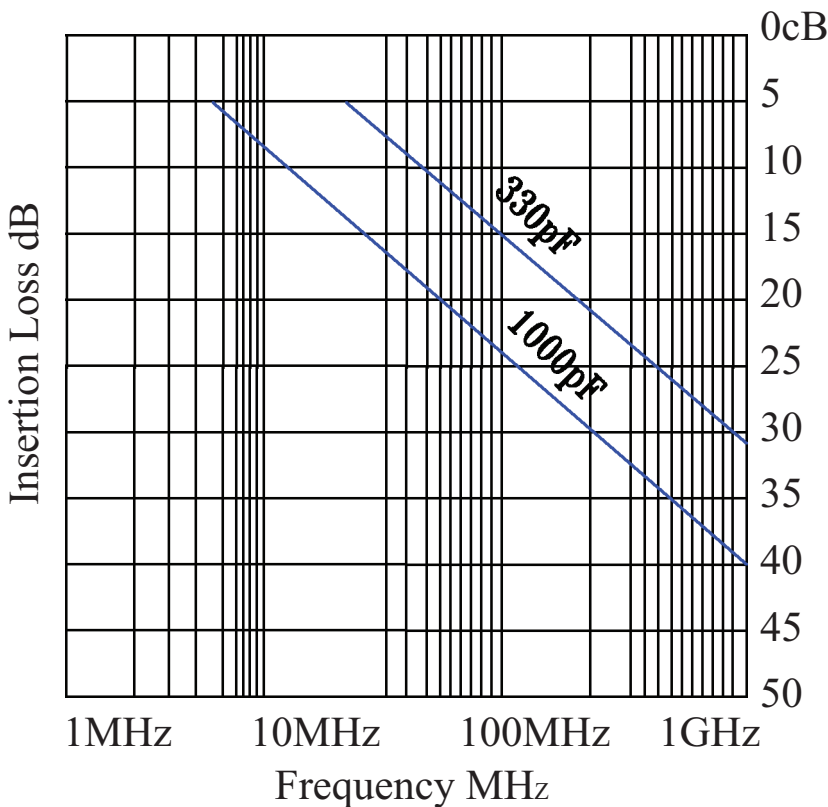

0cB Typical performance relates to 50 Ω system.
 Mill-Std, – Measured at 1KHz 0.1rms

1 – 1000pF
 3 – 330pF

Termination options Straight flow solder
 OL2

Number of Contacts 15 26 44 62

Maximum Insertion & Extraction Force 45 76 125 174N

Performance Level 2

Plug Contact Material Copper Alloy

Skt Contact Material Copper Alloy

Shell Materials Front: Steel - Bright Tin finish
 Rear: Steel –Electrolytic
 Nickel finish
 (Grounding indents on Plugs only)

Capacitance 330pF, Tol +50% -20%
 1000pF, Tol +80% -20%

Working Voltage 200V d.c. or a.c. peak

Contact Resistance $5 \times 10^{-3} \Omega$ max

Insulation Resistance $\geq 5 \times 10^9 \Omega$

Insulator Material UL94V-0 rated +
 High impact Epoxy

Current Rating 5A

Temperature Range -25°C to +125°C

Dimensions for High Density Filter D Sub Connectors

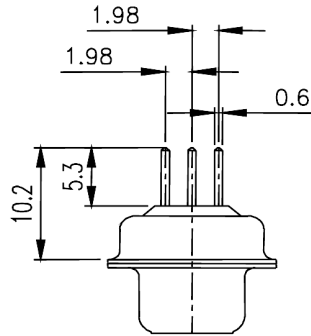

PCB Mounting Details

Positive	A	B	C	D
15M / F	25.0	2.29	1.145	7.04
26M / F	33.3	2.29	1.145	6.88
44M / F	47.1	2.29	1.145	6.88
62M / F	63.5	2.41	1.205	7.00

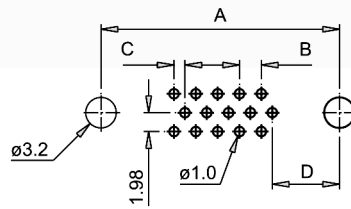

15 Position Female

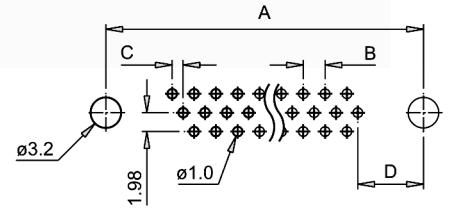

26, 44, 62 Position Female

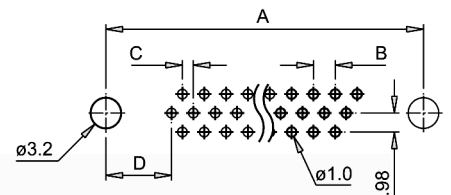
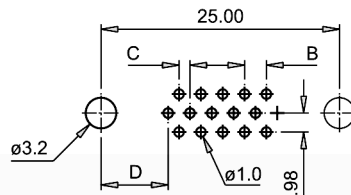

Panel Mounting Details

Rear

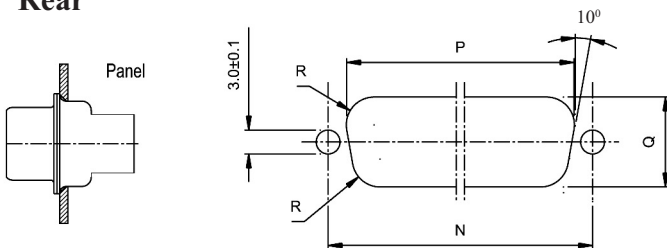

Front

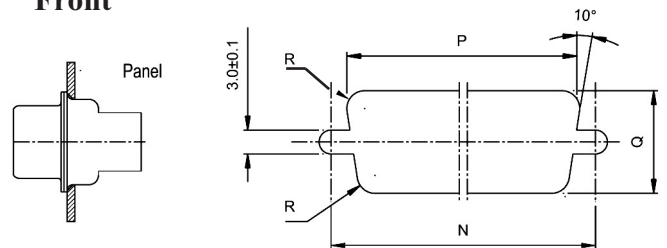

Number of contacts	Dimensions (mm)					
	$N \pm (0.2)$	$P \pm (0.2)$		$Q \pm (0.2)$		$R \pm (0.2)$
	Standard	Float Mount	Standard	Float Mount	Standard	Standard
16	24.99	20.32	21.16	11.30	12.09	3.50
26	33.32	28.70	29.49	11.30	12.09	3.50
44	47.04	42.42	43.20	11.30	12.09	3.50
62	63.50	58.93	59.77	11.30	12.09	3.50

Number of contacts	Dimensions (mm)					
	$N \pm (0.2)$	$P \pm (0.2)$		$Q \pm (0.2)$		$R \pm (0.2)$
	Standard	Float Mount	Standard	Float Mount	Standard	Standard
15	24.99	22.07	22.88	12.90	13.71	2.25
26	33.32	30.40	31.22	12.90	13.71	2.25
44	47.04	44.14	44.95	12.90	13.71	2.25
62	63.50	60.60	61.42	12.90	13.71	2.25



Proven Excellence

For over 70 years, Cinch has been a reliable supplier of a variety of quality connector products to various industries. We are a multi-national manufacturer with manufacturing facilities in the U.S., U.K. and Mexico.

Cinch has applied its extensive expertise in interconnection technology to engineer and manufacture connectors of various complexities using state-of-the-art technology and tooling. Mechanical design is accomplished using Pro/E® 3D solid modeling and AutoCAD® supported by nonlinear and linear Finite Element Analysis, and Mold Flow software.

Our engineers utilize in-house capabilities in high frequency interconnect simulation, SPICE model generation and high frequency testing to develop the optimum product.

All products are validated in Cinch's First Article, mechanical, electrical, and environmental test facilities ensuring the finished products meet our customers' most stringent specifications.

Simply, your connectors are manufactured in state-of-the-art facilities that are committed to customer satisfaction and continuous improvement.



Cinch Connectors
1700 Finley Road
Lombard, IL 60148 USA
Phone: 1.630.705.6000
1.800.323.9612
Fax: 1.630.705.6060
E-mail: info@cinch.com

Cinch Connectors Ltd.
Shireoaks Road Worksop
S80 3HA
Nottinghamshire, U.K.
Phone: 44.1.909.474131
Fax: 44.1.909.478321
E-mail: info@cinchuk.com