

HMK .100 x .100 HYPERBOLOID SERIES



HYPERBOLOID CONNECTORS

FOR SUPERIOR PERFORMANCE IN ALL APPLICATIONS

IEH CORPORATION ISO 9001

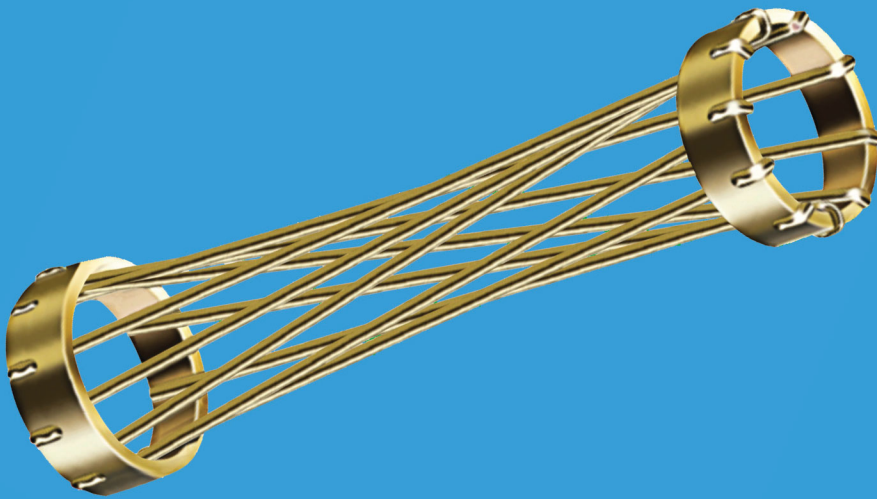

www.iehcorp.com

CONTENTS

HMK SERIES - .100 X .100 CONNECTORS

PAGE

- 5 Introduction
- 6 Specifications

- 7 Ordering Chart - 2 & 3 Row

2 ROW UNINTERRUPTED (17-65 CONTACTS)

- 8 FC, FD, FS, FW, SC, SD, SS, SW- Socket, Straight (Crimp, Dip Solder, Solder Cup, Wire Wrap)
- 9 FE, SE - Socket, Right Angle (Dip Solder)
- 10 FV, SV - Socket, Compliant
- 11 MC, MD, MS, MW, PC, PD, PS, PW - Pin, Straight (Crimp, Dip Solder, Solder Cup, Wire Wrap)
- 12 ME, PE - Pin, Right Angle (Dip Solder)
- 13 MV, PV - Pin, Compliant

2 ROW INTERRUPTED (72-120 CONTACTS)

- 14 FC, FD, FS, FW, SC, SD, SS, SW- Socket, Straight (Crimp, Dip Solder, Solder Cup, Wire Wrap)
- 15 FE, SE - Socket, Right Angle (Dip Solder)
- 16 FV, SV - Socket, Compliant
- 17 MC, MD, MS, MW, PC, PD, PS, PW - Pin, Straight (Crimp, Dip Solder, Solder Cup, Wire Wrap)
- 18 ME, PE - Pin, Right Angle (Dip Solder)
- 19 MV, PV - Pin, Compliant

3 ROW UNINTERRUPTED (62-98 CONTACTS)

- 20 FC, FD, FS, FW, SC, SD, SS, SW- Socket, Straight (Crimp, Dip Solder, Solder Cup, Wire Wrap)
- 21 FE, SE - Socket, Right Angle (Dip Solder)
- 22 FV, SV - Socket, Compliant
- 23 MC, MD, MS, MW, PC, PD, PS, PW - Pin, Straight (Crimp, Dip Solder, Solder Cup, Wire Wrap)
- 24 ME, PE - Pin, Right Angle (Dip Solder)
- 25 MV, PV - Pin, Compliant

CONTENTS

HMK SERIES - .100 X .100 CONNECTORS

PAGE

3 ROW INTERRUPTED (126 CONTACTS)

- 26 FC, FD, FS, FW, SC, SD, SS, SW- Socket, Straight (Crimp, Dip Solder, Solder Cup, Wire Wrap)
- 27 FE, SE - Socket, Right Angle (Dip Solder)
- 28 FV, SV - Socket, Compliant
- 29 MC, MD, MS, MW, PC, PD, PS, PW - Pin, Straight (Crimp, Dip Solder, Solder Cup, Wire Wrap)
- 30 ME, PE - Pin, Right Angle (Dip Solder)
- 31 MV, PV - Pin, Compliant

3 ROW INTERRUPTED (160 CONTACTS)

- 32 FC, FD, FS, FW, SC, SD, SS, SW- Socket, Straight (Crimp, Dip Solder, Solder Cup, Wire Wrap)
- 33 FE, SE - Socket, Right Angle (Dip Solder)
- 34 FV, SV - Socket, Compliant
- 35 MC, MD, MS, MW, PC, PD, PS, PW - Pin, Straight (Crimp, Dip Solder, Solder Cup, Wire Wrap)
- 36 ME, PE - Pin, Right Angle (Dip Solder)
- 37 MV, PV - Pin, Compliant
- 38 FD,FW - Socket, Front Removable, Straight (Dip Solder, Wire Wrap)

- 39 Ordering Chart - 4 & 5 Row

4 ROW UNINTERRUPTED (48-196 CONTACTS)

- 40 FC, FD, FS, FW, SC, SD, SS, SW- Socket, Straight (Crimp, Dip Solder, Solder Cup, Wire Wrap)
- 41 FE, SE - Socket, Right Angle (Dip Solder)
- 42 FV, SV - Socket, Compliant
- 43 MC, MD, MS, MW, PC, PD, PS, PW - Pin, Straight (Crimp, Dip Solder, Solder Cup, Wire Wrap)
- 44 ME, PE - Pin, Right Angle (Dip Solder)
- 45 MV, PV - Pin, Compliant

4 ROW INTERRUPTED (208-392 CONTACTS)

- 46 FC, FD, FS, FW, SC, SD, SS, SW- Socket, Straight (Crimp, Dip Solder, Solder Cup, Wire Wrap)
- 47 FE, SE - Socket, Right Angle (Dip Solder)

CONTENTS

HMK SERIES - .100 X .100 CONNECTORS

PAGE

48	FV, SV - Socket, Compliant
49	MC, MD, MS, MW, PC, PD, PS, PW - Pin, Straight (Crimp, Dip Solder, Solder Cup, Wire Wrap)
50	ME, PE - Pin, Right Angle (Dip Solder)
51	MV, PV - Pin, Compliant

5 ROW UNINTERRUPTED (125-240 CONTACTS)

52	FC, FD, FS, FW, SC, SD, SS, SW- Socket, Straight (Crimp, Dip Solder, Solder Cup, Wire Wrap)
53	FE, SE - Socket, Right Angle (Dip Solder)
54	FV, SV - Socket, Compliant
55	MC, MD, MS, MW, PC, PD, PS, PW - Pin, Straight (Crimp, Dip Solder, Solder Cup, Wire Wrap)
56	ME, PE - Pin, Right Angle (Dip Solder)
57	MV, PV - Pin, Compliant

5 ROW INTERRUPTED (300-490 CONTACTS)

58	FC, FD, FS, FW, SC, SD, SS, SW- Socket, Straight (Crimp, Dip Solder, Solder Cup, Wire Wrap)
59	FE, SE - Socket, Right Angle (Dip Solder)
60	FV, SV - Socket, Compliant
61	MC, MD, MS, MW, PC, PD, PS, PW - Pin, Straight (Crimp, Dip Solder, Solder Cup, Wire Wrap)
62	ME, PE - Pin, Right Angle (Dip Solder)
63	MV, PV - Pin, Compliant

APPENDIX

64	Termination Styles - Socket, 2 Row
65	Termination Styles - Pin, 2 Row
66	Termination Styles - Socket, 3 Row
67	Termination Styles - Pin, 3 Row
68	Termination Styles - Socket, 4 Row
69	Termination Styles - Pin, 4 Row
70	Termination Styles - Socket, 5 Row
71	Termination Styles - Pin, 5 Row
72	Hardware Styles- Receptacle, 2 & 3 Row
73	Hardware Styles- Plug, 2 & 3 Row
74	Hardware Styles- Receptacle, 4 & 5 Row

CONTENTS
HMK SERIES - .100 X .100 CONNECTORS

PAGE

75	Hardware Styles- Plug, 4 & 5 Row
76	PWB Pattern - 2 Row Uninterrupted
77	PWB Pattern - 2 Row Interrupted
78	PWB Pattern - 3 Row Uninterrupted
79	PWB Pattern - 3 Row Interrupted 126
80	PWB Pattern - 3 Row Interrupted 160
81	PWB Pattern - 4 Row Uninterrupted
82	PWB Pattern - 4 Row Interrupted
83	PWB Pattern - 5 Row Uninterrupted
84	PWB Pattern - 5 Row Interrupted
85	Accessories

The HYPERBOLOID contact is an advanced design that satisfies performance requirements previously considered impossible. Radically different in concept, it is used in connectors having the highest standards of performance. The distinguishing feature of the HYPERBOLOID socket is the hyper-boloid-shaped sleeve formed by straight wires strung at an angle to the longitudinal axis. Viewed from the side, you see a curve defined by a series of apparent short straight line segments which are tangent lines to points along a hyperbolic curve. This geometry provides for a design which has a decreasing circumscribed circle when viewed from the entry. It begins larger than the pin acceptance diameter and is less than this same diameter at the center. When the pin is inserted into this sleeve, the wires stretch, well within elastic limits, to accommodate it. In so doing, the wires wrap themselves around the pin providing a number of continuous line contact paths. The illustration below will assist in visualization.

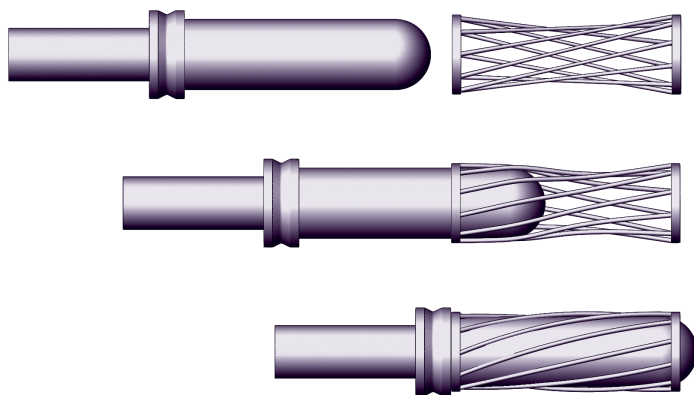
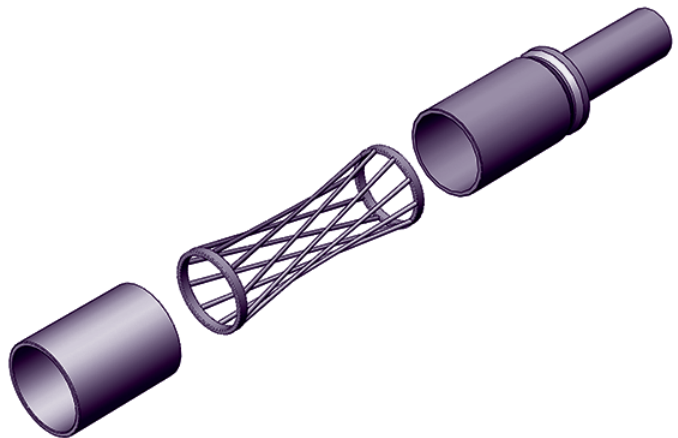

The actual physical construction of the contact involves several components. The wires are strung on an internal wire carrier (inner sleeve) which is subsequently capped or enclosed by a front outer ring (front sleeve) and rear ring which includes the termination configuration (terminal). All components to the assembly are completely finished with the specified electroplating prior to assembly. The wires are continuous process plated on reel before use. In this manner, interface finish requirements can be controlled very closely without the common problems of gradient, shadow, or other finish imperfections often appearing in alternative designs. Very often, this processing feature permits the specifier to reduce precious metal content with resultant savings. Joints are calculated interference fits, insuring gas tight interfaces between all elements of the HYPERBOLOID construction. An exploded view is provided next.

The unique geometry, precision processing, and careful attention to quality result in a highly desirable contact design which provides:

- **VLIF (Very Low Insertion Force):** Common sizes #22 and less average under one ounce per contact.
- **Extraordinary Resistance to Shock & Vibration:** Tests exceeding 300 g's without discontinuity.
- **Duty Cycle Exceeding 100,000 Mate/Demate:** The burnishing action of the wires on the pin surface is non-destructive. Unlike the "plow" and scrape action of common designs, HYPERBOLOID's gentle mating action enhances life.
- **Low, Low Contact Resistance:** The multiplicity of line contact, as opposed to point contact in other designs, provides an excellent interface exhibiting low contact resistance (often less than 1/2 of MIL spec. allowances). This characteristic also provides for a cooler running contact under load.
- **Improved Current Carrying Capacity:** The low contact resistance gives a lower °C rise from ambient under load. This feature often allows the user to operate the same size contact under high load.
- **Highest Reliability:** In use for over 40 years under the most demanding conditions HYPERBOLOID has proven itself to be the leading design for integrity and reliability. On space platforms, ships and boats at sea, land vehicles, fighter and transport aircraft, missiles, torpedoes, medical and transplant electronics, industrial and environmental controls, rail, construction, ATE and test equipment, PGA sockets, test interface stations, and other applications, HYPERBOLOID has lived up to its promise of the highest reliability connector available.

SPECIFICATIONS

MATERIALS:

Pin Contacts:	PhBr per ASTM B139, BeCu per ASTM B196, or Cu alloy
Socket Contacts:	
Contact Wires:	BeCu per ASTM B197
Termination:	PhBr per ASTM B139 or Cu alloy
Support Elements:	Cu alloy
Hardware:	Corrosion resistant steel per ASTM A582 or Brass per ASTM B16 or Cu alloy
Insulator:	Glass Filled Diallyl Phthalate per ASTM D5948 Modified polyphenylene sulfide per MIL-M-24519, Type GST-40F
Pin Shields:	Aluminum 5052-H32 per QQ-A-250/8

FINISHES:

Pin Contacts:	Gold per ASTM B488 or MIL-DTL-45204 Type II, Class 1.27 min. , Code C over Nickel, 0.000050 min., per SAE-AMS-QQ-N-290 over Copper per SAE AMS 2418
Socket Contacts:	
Contact Wires:	Gold per ASTM B488 or MIL-DTL-45204 Type II, Class 1.27 min. , Code C over Nickel, 0.000050 min., per SAE-AMS-QQ-N-290 over Copper per SAE AMS 2418
Termination:	Gold per ASTM B488 or MIL-DTL-45204 , Class 0.50 min. , Grade C over Nickel, 0.000050 min., per SAE-AMS-QQ-N-290 over Copper per SAE AMS 2418 or solder dip over Nickel, 0.000050 min., per SAE-AMS-QQ-N-290 over Copper per SAE AMS 2418
Support Elements:	Nickel, 0.000050 min., over Copper per SAE AMS 2418
Hardware:	CRES - Passivate per SAE-AMS2700 Cu alloy - Nickel plate, 0.000050 min.
Pin Shields:	Gold Anodize per MIL-A-8625, Type II, Class 2

PERFORMANCE:

Current Rating:	4 amp @ 30°C Rise (higher ratings may be supported--contact factory)
Insulation Resistance:	10 ⁶ megohms min. - EIA-364-21 & MIL-DTL-55302 (par. 4.5.8) @500 VDC
Contact Resistance:	5 milliohms max, - EIA-364-06 & MIL-DTL-55302 (par. 4.5.5)
Breakdown Voltage between contacts:	1400V RMS min
Dielectric Withstanding Voltage:	1050V RMS min
Temperature:	-55°C to +125°C (-67°F to +257°F)
De-mating Force:	0.30 to 2.00 oz. per contact x number of contacts - MIL-STD-55302 (par. 4.5.4)
Contact Life:	100,000 mating cycles - Exceeds MIL-DTL-55302 (par. 4.5.9)
Solderability:	IPC/EIA J-STD-002, Category 3
Humidity:	IAW EIA-364-31, Method IV, except 7A & 7B (not required)
Vibration:	IAW EIA-364-28 & MIL-DTL-55302 (par. 4.5.10)
Shock:	IAW EIA-364-27 & MIL-DTL-55302 (par. 4.5.14)
Salt Spray:	IAW EIA-364-26 & MIL-DTL-55302 (par. 4.5.11)
Temperature Cycling:	IAW EIA-364-32 & MIL-DTL-55302 (par. 4.5.13)

DIMENSIONS:

Catalog product dimensions are nominal.
For linear and positional tolerances, contact factory.

All information contained herein is believed to be reliable as of the date of publication, but is subject to change without notice. Current product drawings and specifications are available upon request from IEH.

IEH warrants its products to be free of defects affecting normal use. If any shipment is found to be defective we will accept return for repair or replacement at our option within one year of shipment. IEH is not responsible for incidental or consequential damages arising out of the use of our products.

ORDERING CHART 2 & 3 - Row

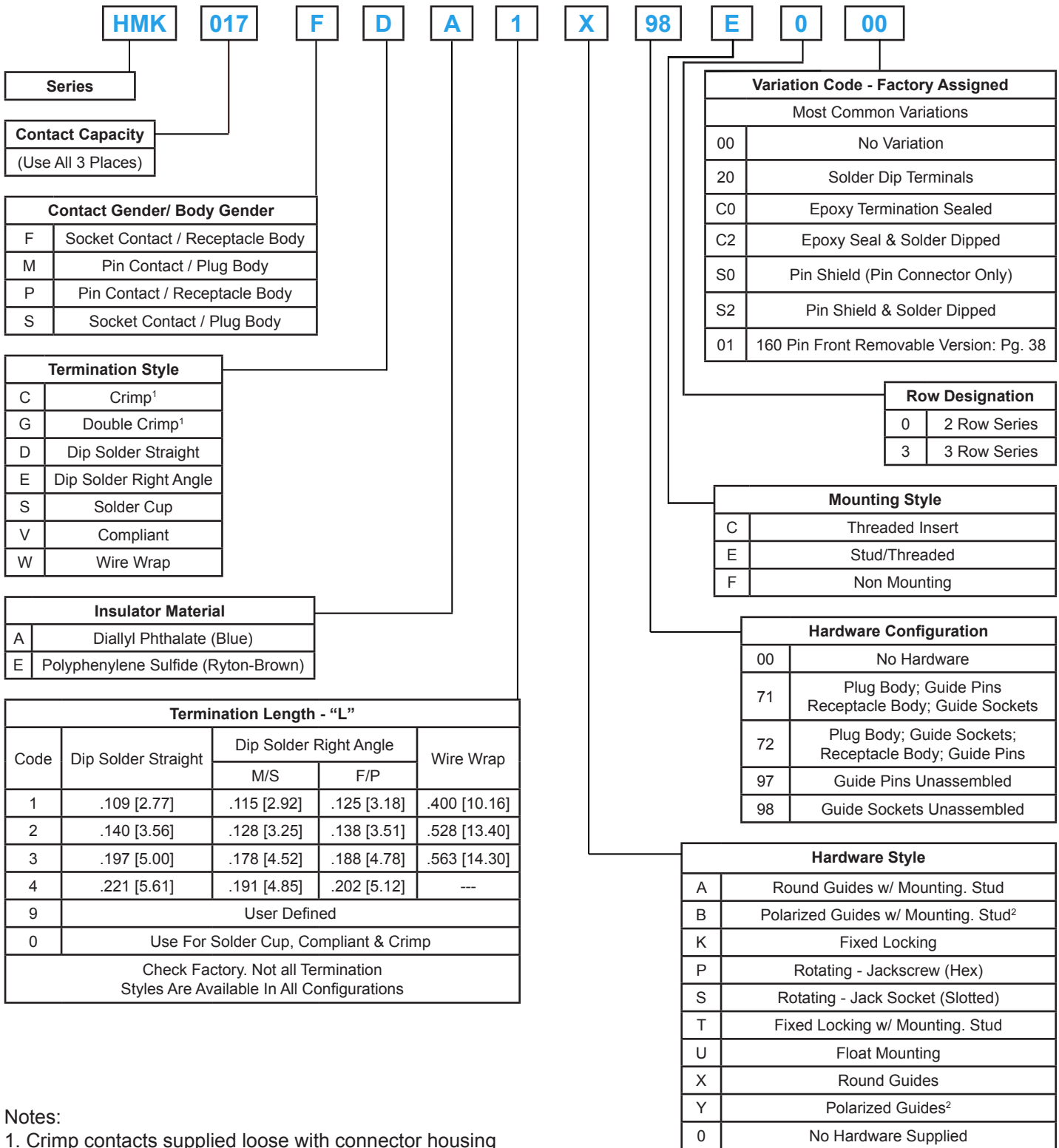

Notes:
 1. Crimp contacts supplied loose with connector housing
 2. Keying is available in 36 styles. If not specified, will be supplied in position C3. The user can change the keying position

SOCKET, STRAIGHT
STYLE FC, FD, FS, FW
STYLE SC, SD, SS, SW

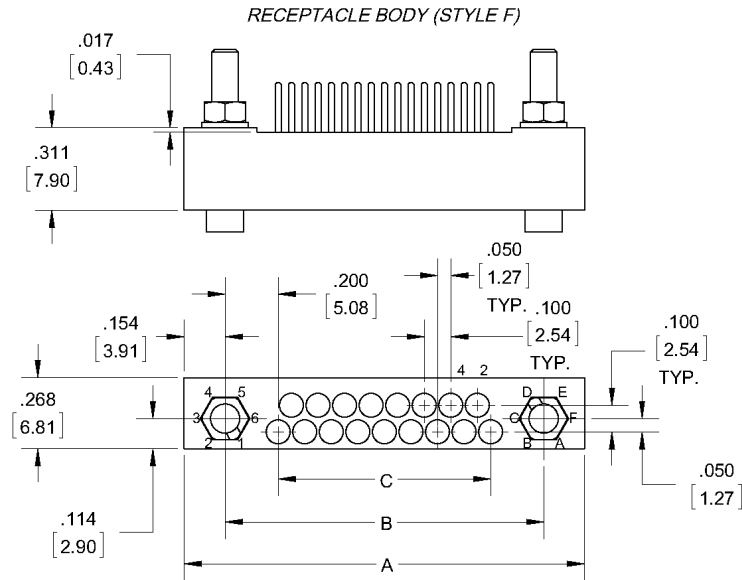
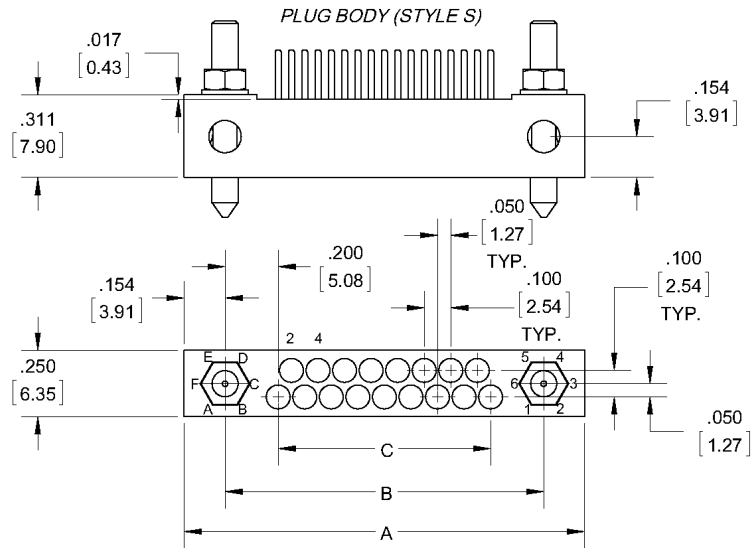

No. of Contacts	A	B	C
17	1.508 [38.30]	1.200 [30.48]	0.800 [20.32]
29	2.106 [53.49]	1.800 [45.72]	1.400 [35.56]
33	2.308 [58.62]	2.000 [50.80]	1.600 [40.64]
41	2.708 [68.78]	2.400 [60.96]	2.000 [50.80]
53	3.308 [84.02]	3.000 [76.20]	2.600 [66.04]
65	3.908 [99.26]	3.600 [91.44]	3.200 [81.28]

**REFER TO APPENDIX FOR TERMINATION DETAILS,
 HARDWARE STYLES, AND PWB PATTERNS**

SOCKET, RIGHT ANGLE STYLE FE STYLE SE

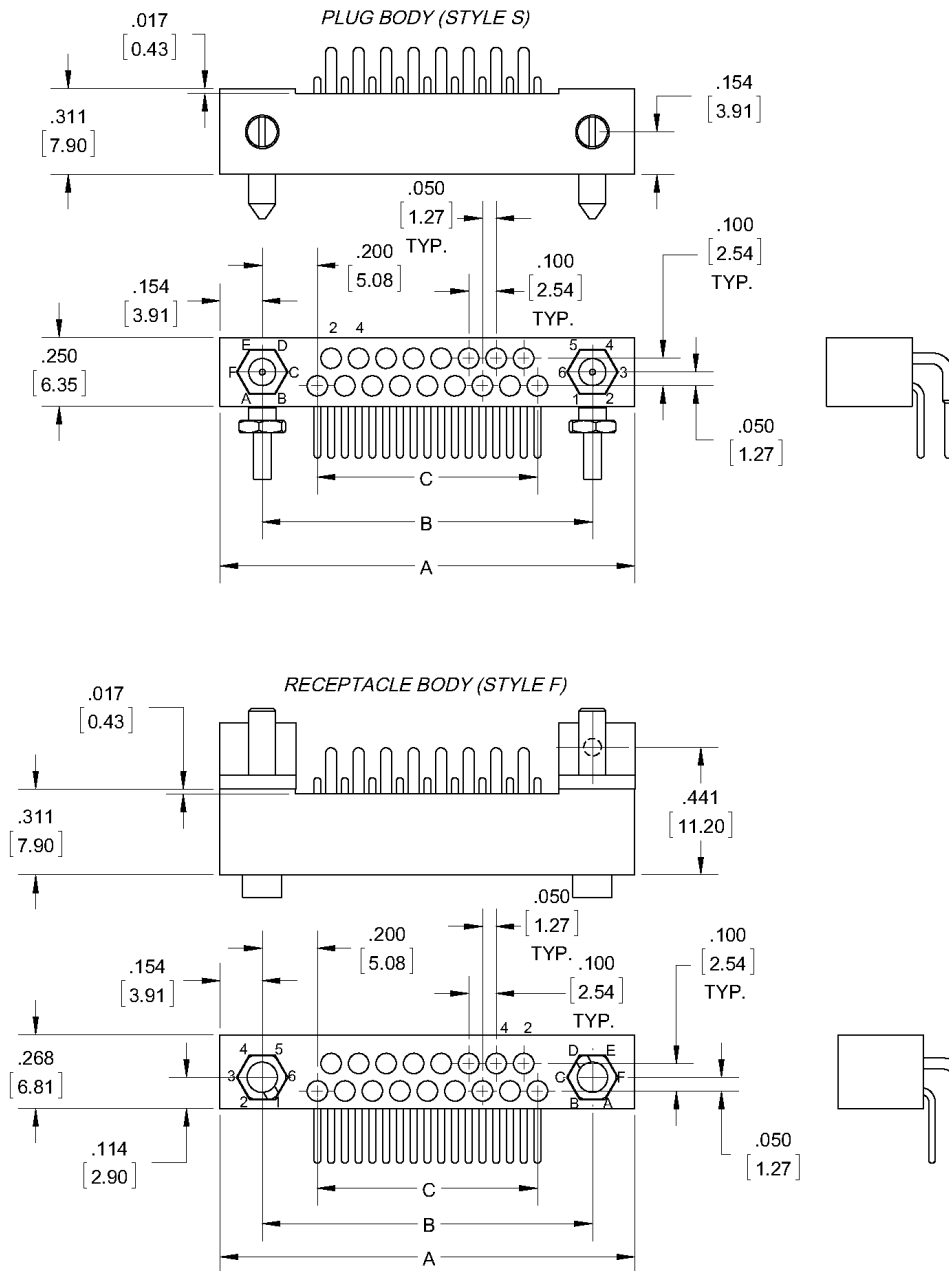

No. of Contacts	A	B	C
17	1.508 [38.30]	1.200 [30.48]	0.800 [20.32]
29	2.106 [53.49]	1.800 [45.72]	1.400 [35.56]
33	2.308 [58.62]	2.000 [50.80]	1.600 [40.64]
41	2.708 [68.78]	2.400 [60.96]	2.000 [50.80]
53	3.308 [84.02]	3.000 [76.20]	2.600 [66.04]
65	3.908 [99.26]	3.600 [91.44]	3.200 [81.28]

**REFER TO APPENDIX FOR TERMINATION DETAILS,
HARDWARE STYLES, AND PWB PATTERNS**

**SOCKET, COMPLIANT
STYLE FV
STYLE SV**

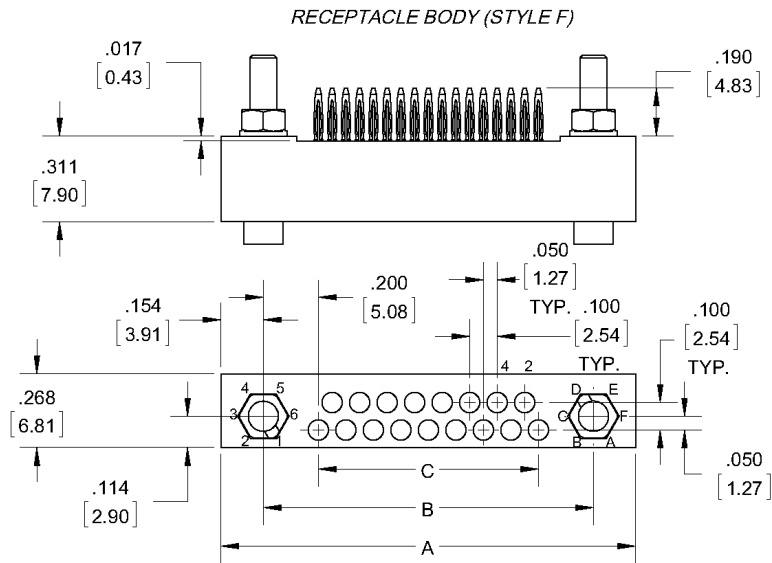
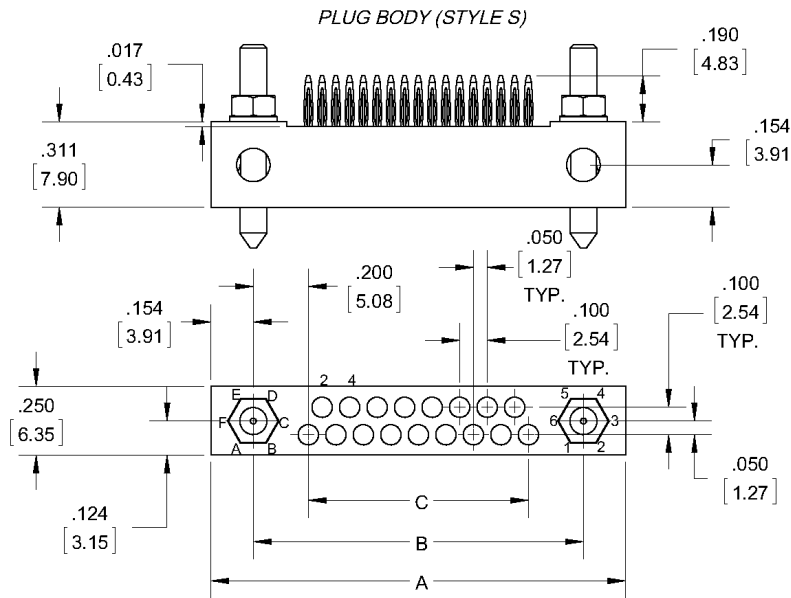

No. of Contacts	A	B	C
17	1.508 [38.30]	1.200 [30.48]	0.800 [20.32]
29	2.106 [53.49]	1.800 [45.72]	1.400 [35.56]
33	2.308 [58.62]	2.000 [50.80]	1.600 [40.64]
41	2.708 [68.78]	2.400 [60.96]	2.000 [50.80]
53	3.308 [84.02]	3.000 [76.20]	2.600 [66.04]
65	3.908 [99.26]	3.600 [91.44]	3.200 [81.28]

**REFER TO APPENDIX FOR TERMINATION DETAILS,
HARDWARE STYLES, AND PWB PATTERNS**

PIN, STRAIGHT STYLE MC, MD, MS, MW STYLE PC, PD, PS, PW

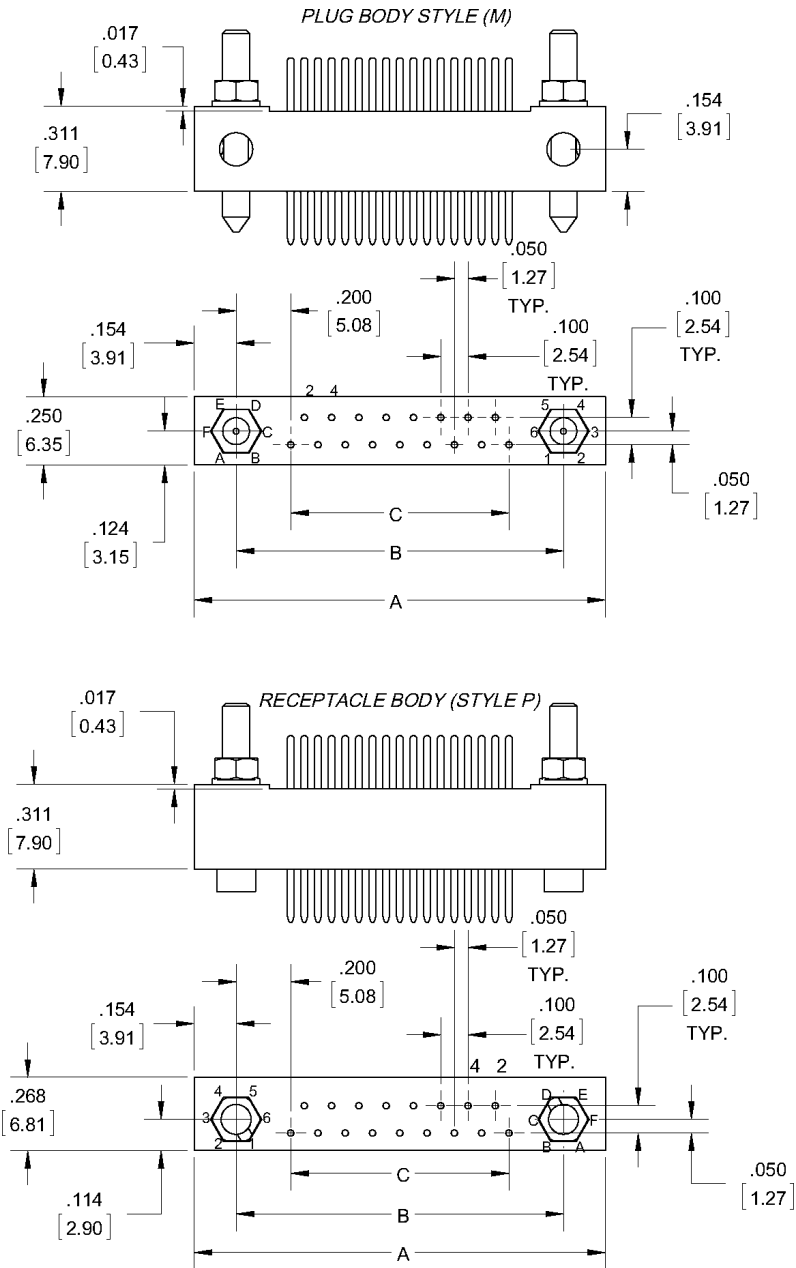

No. of Contacts	A	B	C
17	1.508 [38.30]	1.200 [30.48]	0.800 [20.32]
29	2.106 [53.49]	1.800 [45.72]	1.400 [35.56]
33	2.308 [58.62]	2.000 [50.80]	1.600 [40.64]
41	2.708 [68.78]	2.400 [60.96]	2.000 [50.80]
53	3.308 [84.02]	3.000 [76.20]	2.600 [66.04]
65	3.908 [99.26]	3.600 [91.44]	3.200 [81.28]

REFER TO APPENDIX FOR TERMINATION DETAILS,
HARDWARE STYLES, AND PWB PATTERNS

**PIN, RIGHT ANGLE
STYLE ME
STYLE PE**

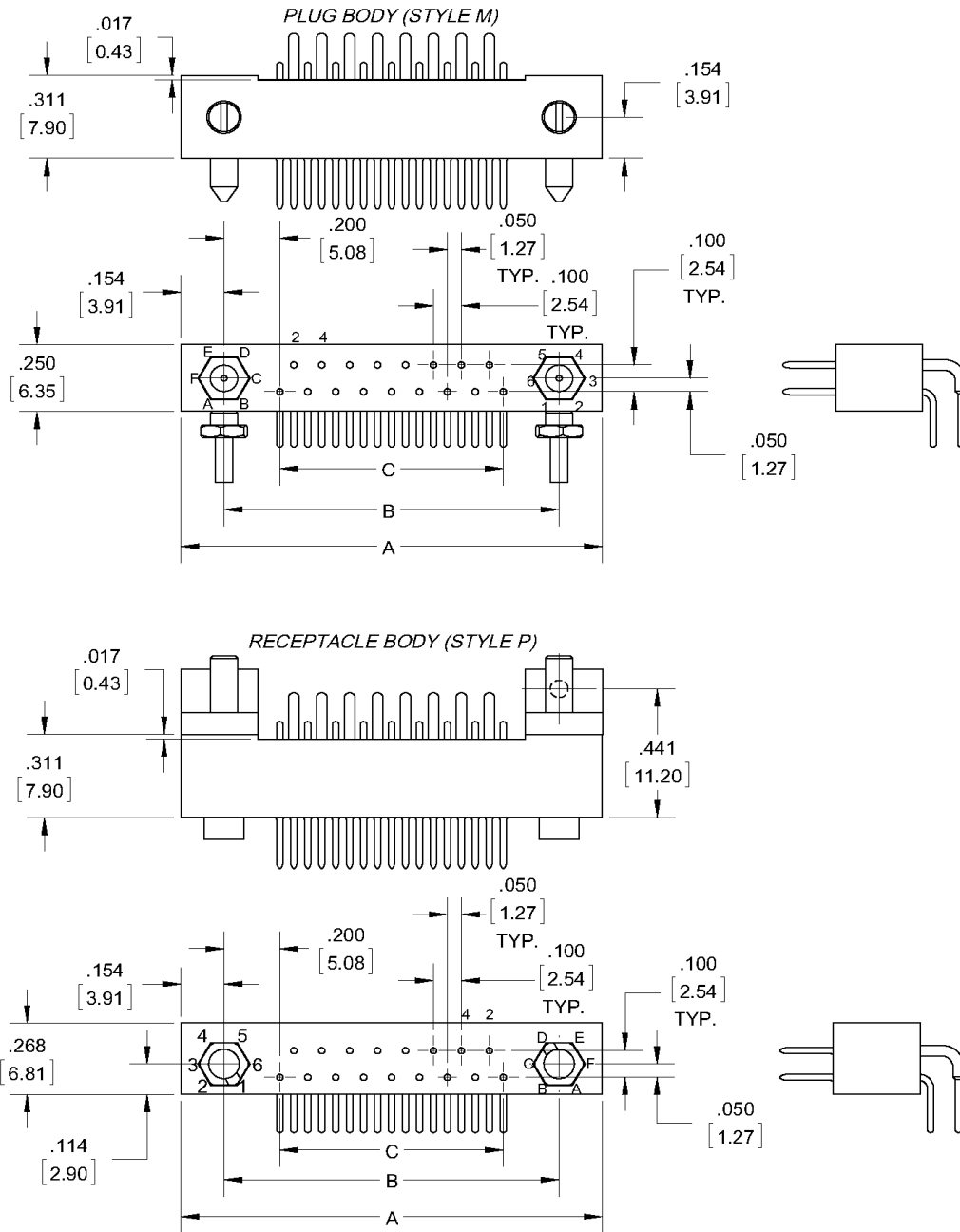

No. of Contacts	A	B	C
17	1.508 [38.30]	1.200 [30.48]	0.800 [20.32]
29	2.106 [53.49]	1.800 [45.72]	1.400 [35.56]
33	2.308 [58.62]	2.000 [50.80]	1.600 [40.64]
41	2.708 [68.78]	2.400 [60.96]	2.000 [50.80]
53	3.308 [84.02]	3.000 [76.20]	2.600 [66.04]
65	3.908 [99.26]	3.600 [91.44]	3.200 [81.28]

**REFER TO APPENDIX FOR TERMINATION DETAILS,
HARDWARE STYLES, AND PWB PATTERNS**

PIN, COMPLIANT STYLE MV STYLE PV

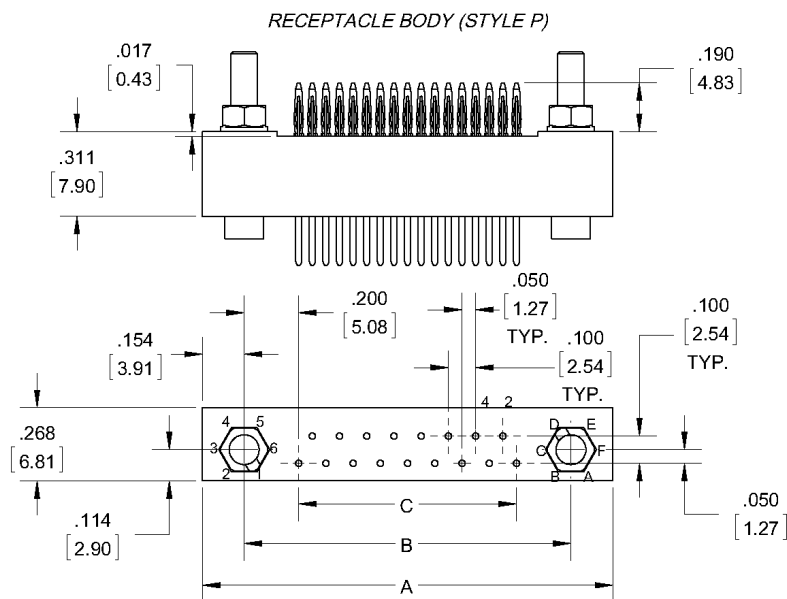
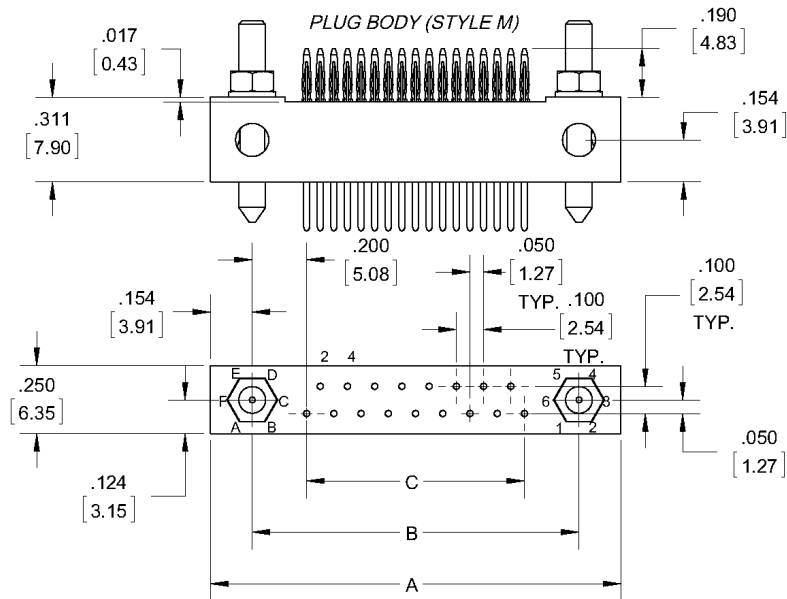

No. of Contacts	A	B	C
17	1.508 [38.30]	1.200 [30.48]	0.800 [20.32]
29	2.106 [53.49]	1.800 [45.72]	1.400 [35.56]
33	2.308 [58.62]	2.000 [50.80]	1.600 [40.64]
41	2.708 [68.78]	2.400 [60.96]	2.000 [50.80]
53	3.308 [84.02]	3.000 [76.20]	2.600 [66.04]
65	3.908 [99.26]	3.600 [91.44]	3.200 [81.28]

**REFER TO APPENDIX FOR TERMINATION DETAILS,
HARDWARE STYLES, AND PWB PATTERNS**

SOCKET, STRAIGHT
STYLE FC, FD, FS, FW
STYLE SC, SD, SS, SW

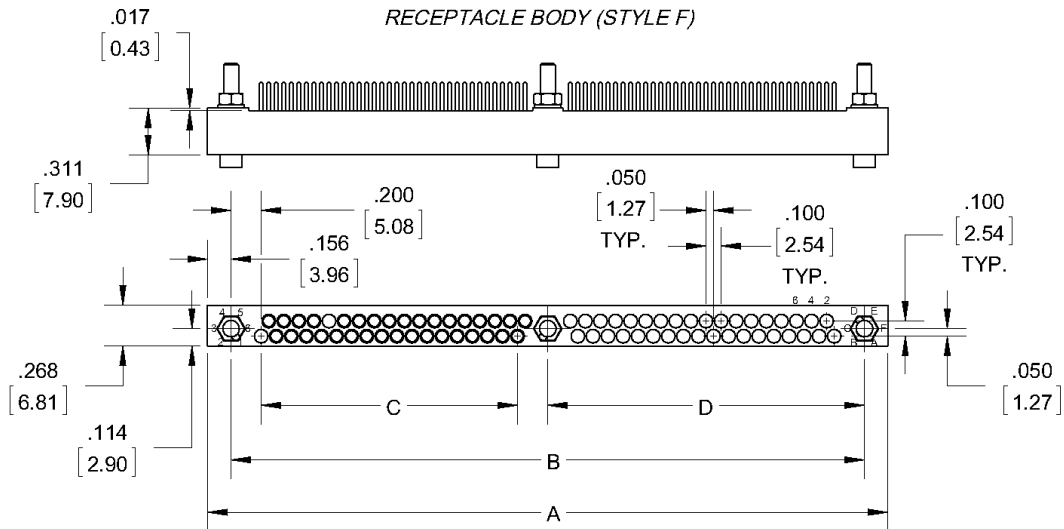
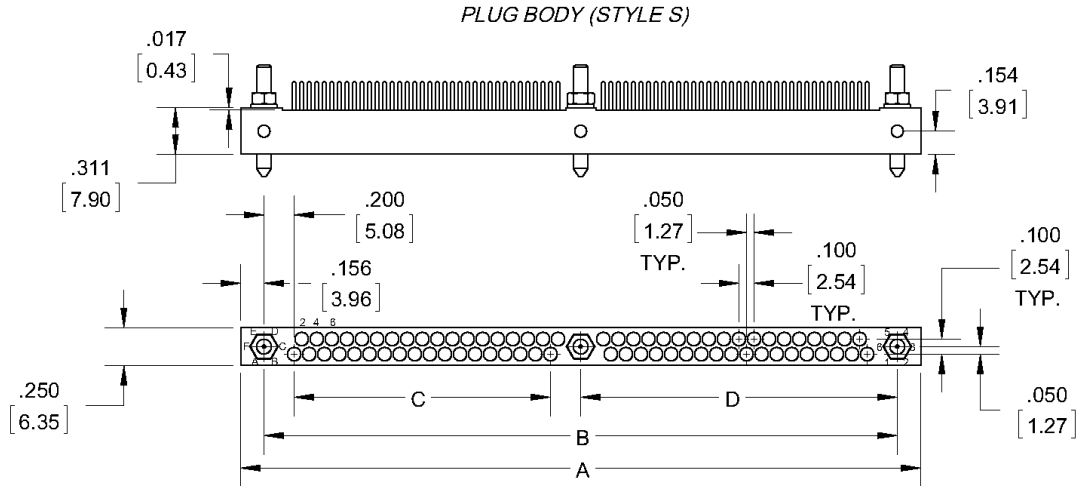

REFER TO APPENDIX FOR TERMINATION DETAILS, HARDWARE STYLES, AND PWB PATTERNS

No. of Contacts	A	B	C	D
72	4.508 [114.50]	4.200 [106.68]	1.700 [43.18]	2.100 [53.34]
84	5.108 [129.74]	4.800 [121.92]	2.000 [50.80]	2.400 [60.96]
96	5.708 [144.98]	5.400 [137.16]	2.300 [58.42]	2.700 [68.58]
120	6.909 [175.50]	6.600 [167.64]	2.900 [73.66]	3.300 [83.82]

SOCKET, RIGHT ANGLE STYLE FE STYLE SE

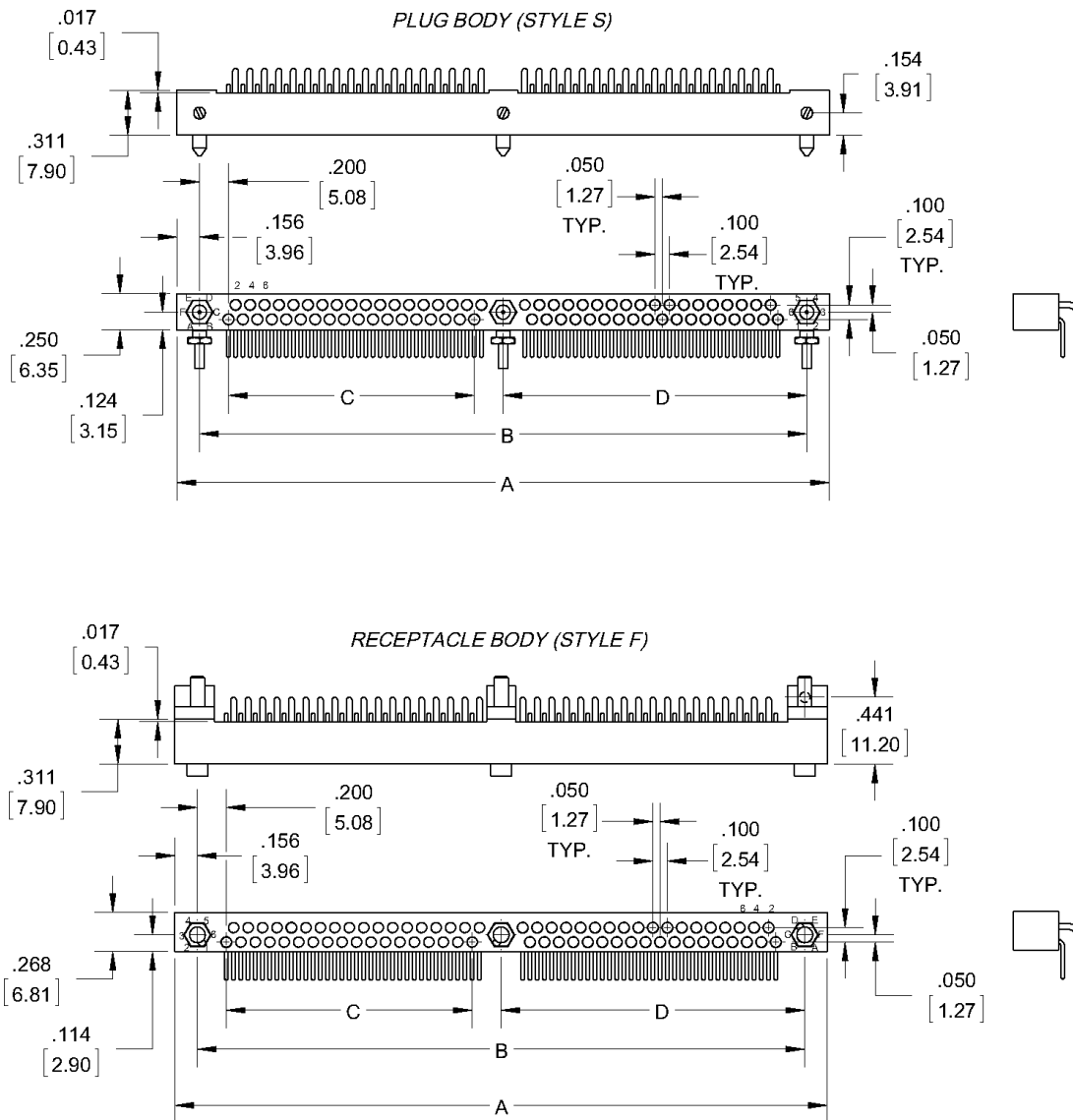

**REFER TO APPENDIX FOR TERMINATION DETAILS, HARDWARE
STYLES, AND PWB PATTERNS**

No. of Contacts	A	B	C	D
72	4.508 [114.50]	4.200 [106.68]	1.700 [43.18]	2.100 [53.34]
84	5.108 [129.74]	4.800 [121.92]	2.000 [50.80]	2.400 [60.96]
96	5.708 [144.98]	5.400 [137.16]	2.300 [58.42]	2.700 [68.58]
120	6.909 [175.50]	6.600 [167.64]	2.900 [73.66]	3.300 [83.82]

**SOCKET, COMPLIANT
STYLE FV
STYLE SV**

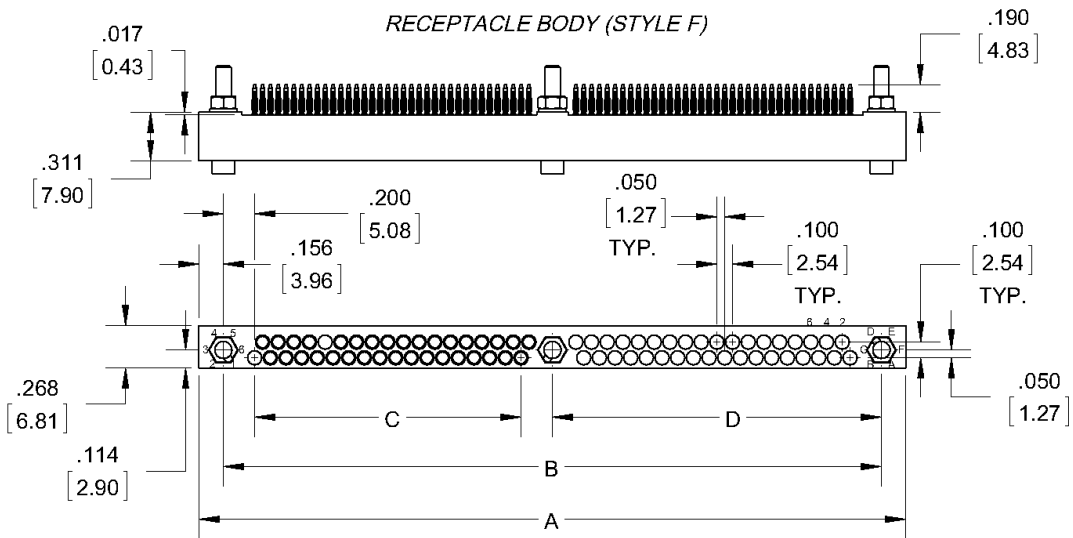
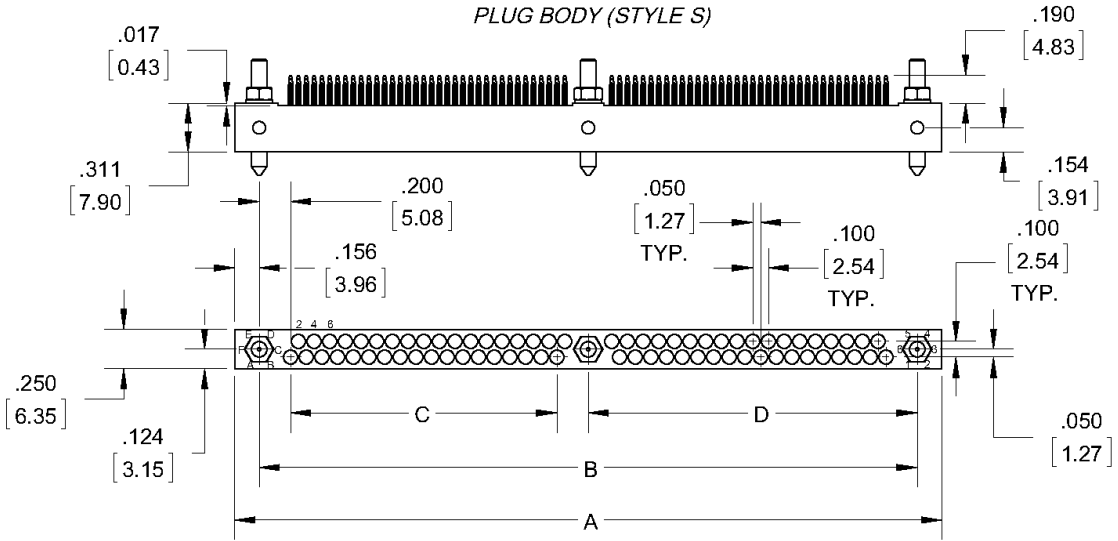

REFER TO APPENDIX FOR TERMINATION DETAILS, HARDWARE STYLES, AND PWB PATTERNS

No. of Contacts	A	B	C	D
72	4.508 [114.50]	4.200 [106.68]	1.700 [43.18]	2.100 [53.34]
84	5.108 [129.74]	4.800 [121.92]	2.000 [50.80]	2.400 [60.96]
96	5.708 [144.98]	5.400 [137.16]	2.300 [58.42]	2.700 [68.58]
120	6.909 [175.50]	6.600 [167.64]	2.900 [73.66]	3.300 [83.82]

**PIN, STRAIGHT
STYLE MC, MD, MS, MW
STYLE PC, PD, PS, PW**

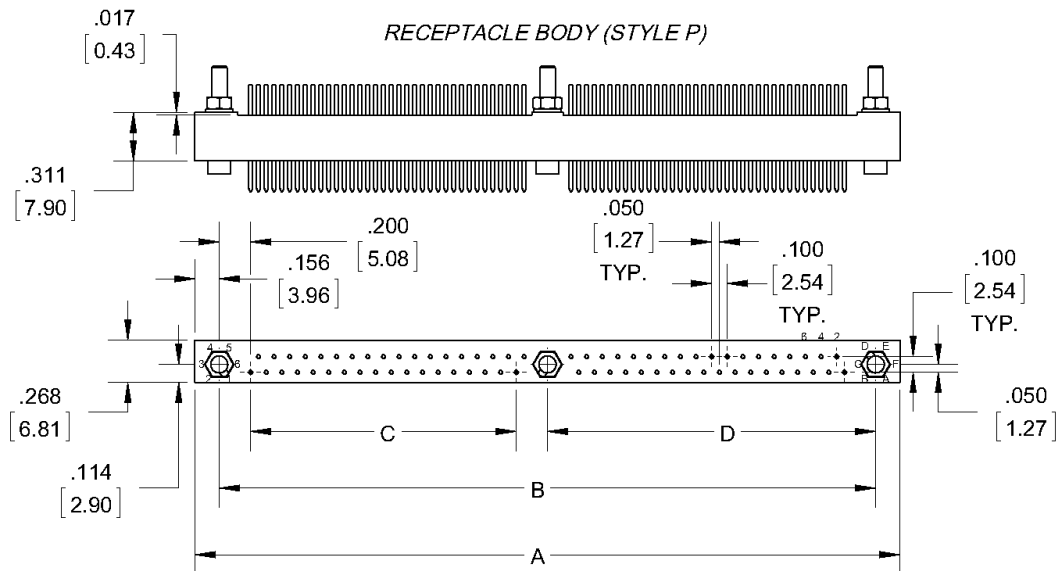
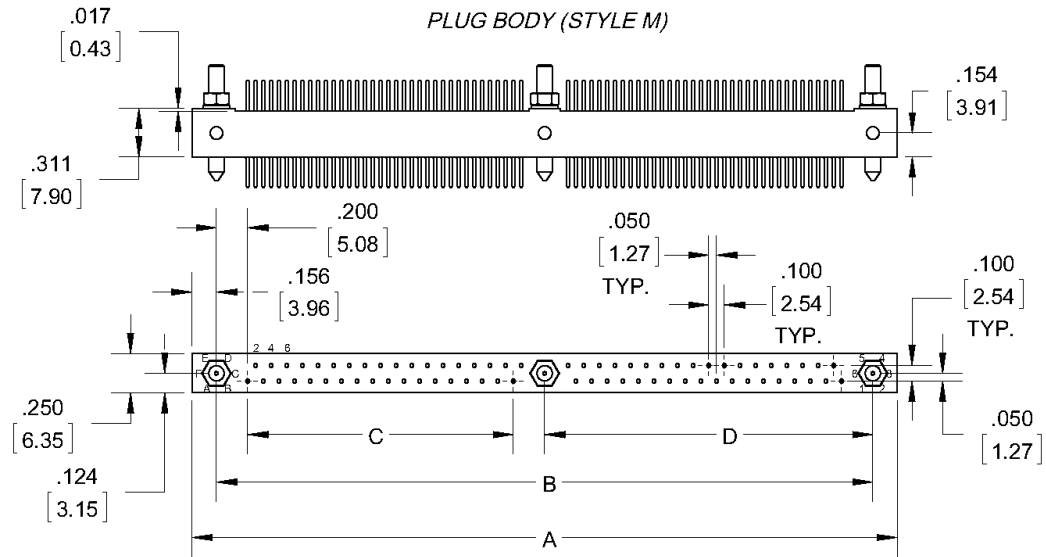

**REFER TO APPENDIX FOR TERMINATION DETAILS, HARDWARE
STYLES, AND PWB PATTERNS**

No. of Contacts	A	B	C	D
72	4.508 [114.50]	4.200 [106.68]	1.700 [43.18]	2.100 [53.34]
84	5.108 [129.74]	4.800 [121.92]	2.000 [50.80]	2.400 [60.96]
96	5.708 [144.98]	5.400 [137.16]	2.300 [58.42]	2.700 [68.58]
120	6.909 [175.50]	6.600 [167.64]	2.900 [73.66]	3.300 [83.82]

**PIN, RIGHT ANGLE
STYLE ME
STYLE PE**

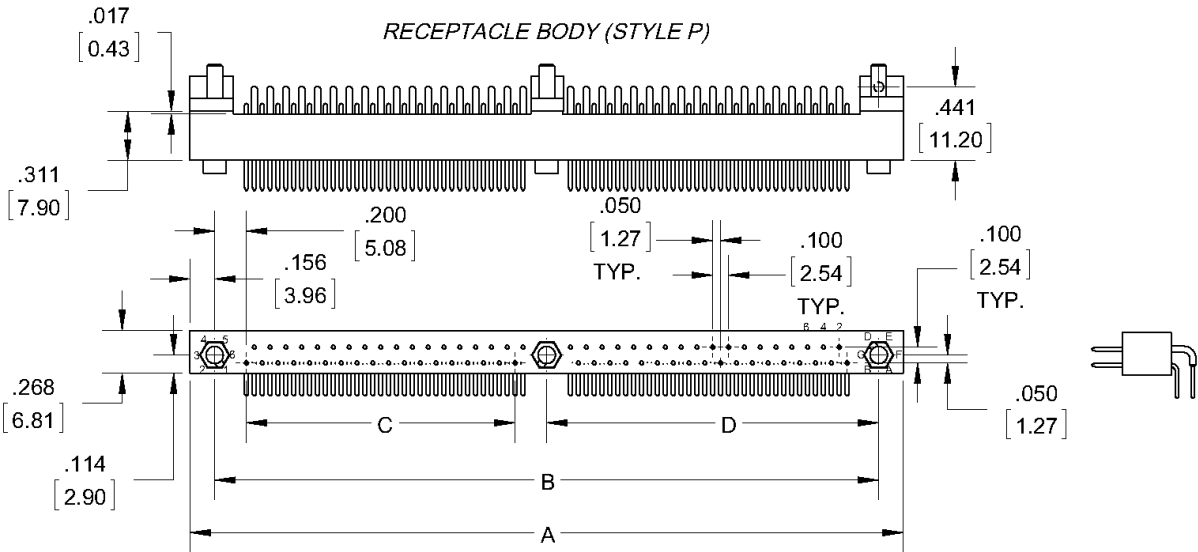
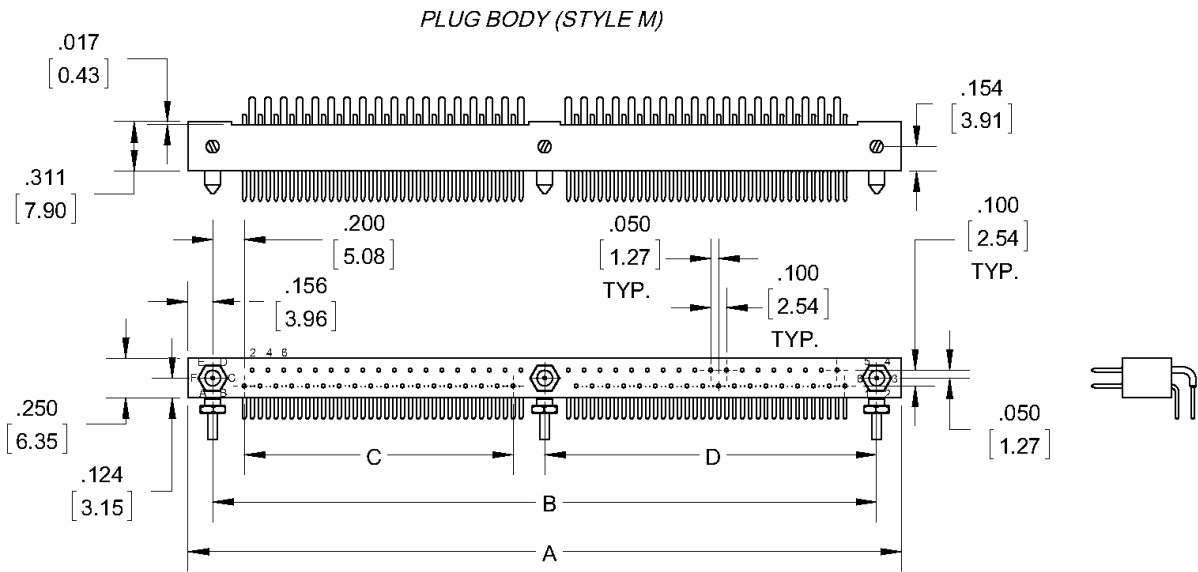

REFER TO APPENDIX FOR TERMINATION DETAILS, HARDWARE STYLES, AND PWB PATTERNS

No. of Contacts	A	B	C	D
72	4.508 [114.50]	4.200 [106.68]	1.700 [43.18]	2.100 [53.34]
84	5.108 [129.74]	4.800 [121.92]	2.000 [50.80]	2.400 [60.96]
96	5.708 [144.98]	5.400 [137.16]	2.300 [58.42]	2.700 [68.58]
120	6.909 [175.50]	6.600 [167.64]	2.900 [73.66]	3.300 [83.82]

**PIN, COMPLIANT
STYLE MV
STYLE PV**

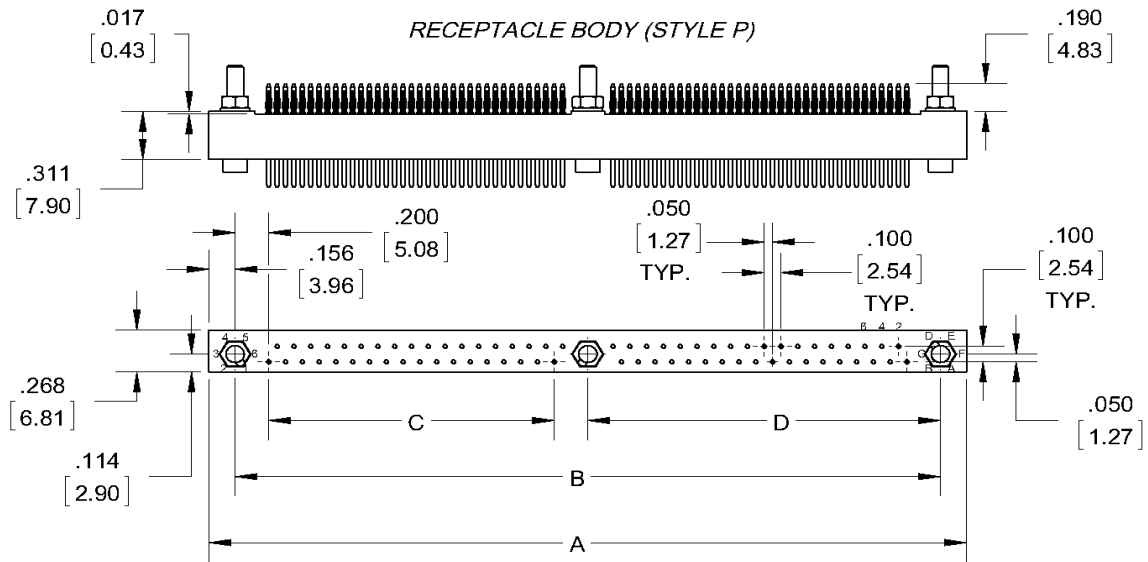
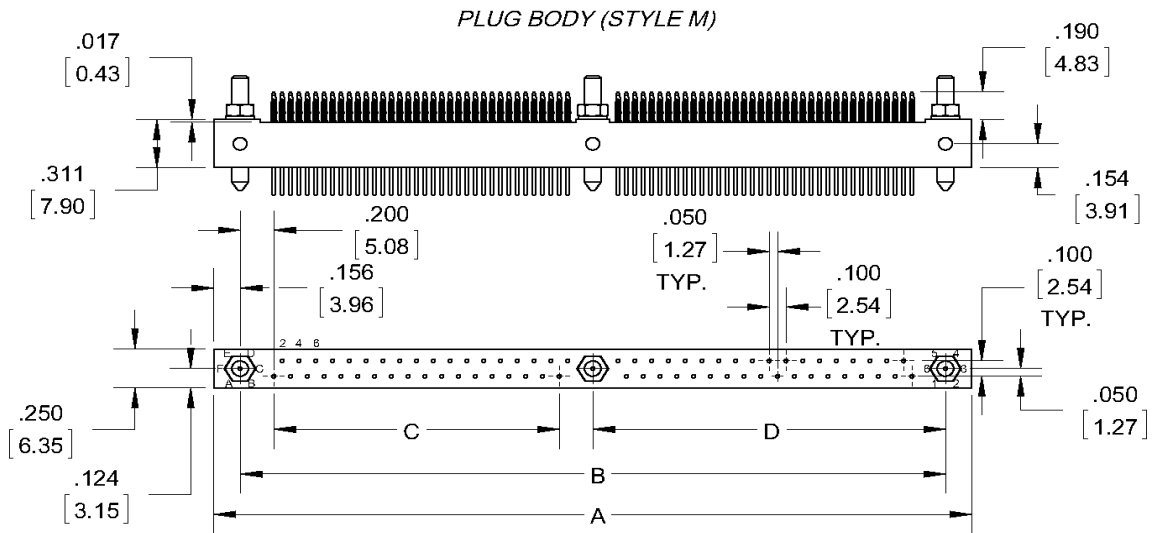

REFER TO APPENDIX FOR TERMINATION DETAILS, HARDWARE STYLES, AND PWB PATTERNS

No. of Contacts	A	B	C	D
72	4.508 [114.50]	4.200 [106.68]	1.700 [43.18]	2.100 [53.34]
84	5.108 [129.74]	4.800 [121.92]	2.000 [50.80]	2.400 [60.96]
96	5.708 [144.98]	5.400 [137.16]	2.300 [58.42]	2.700 [68.58]
120	6.909 [175.50]	6.600 [167.64]	2.900 [73.66]	3.300 [83.82]

SOCKET, STRAIGHT
STYLE FC, FD, FS, FW
STYLE SC, SD, SS, SW

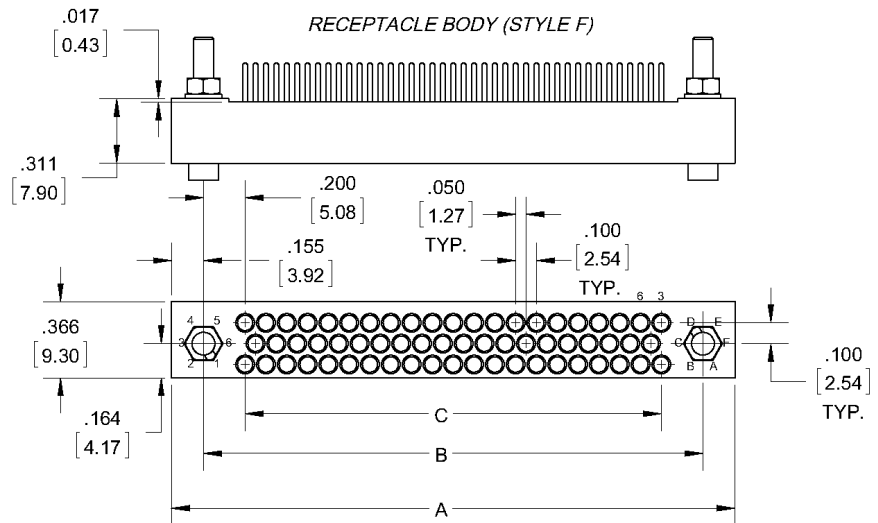
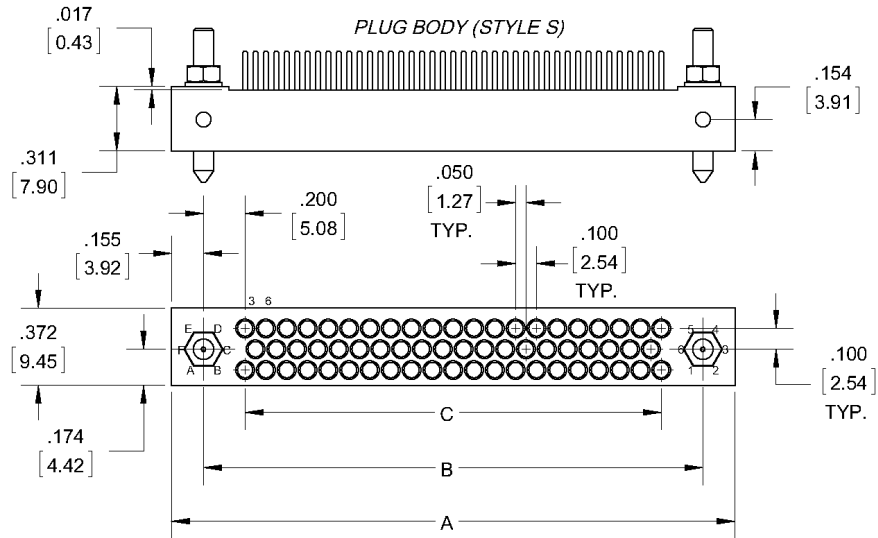

**REFER TO APPENDIX FOR TERMINATION DETAILS, HARDWARE
 STYLES, AND PWB PATTERNS**

No. of Contacts	A	B	C
62	2.707 [68.75]	2.400 [60.96]	2.000 [50.80]
80	3.307 [84.00]	3.000 [76.20]	2.600 [66.04]
98	3.907 [99.24]	3.600 [91.44]	3.200 [81.28]

SOCKET, RIGHT ANGLE STYLE FE STYLE SE

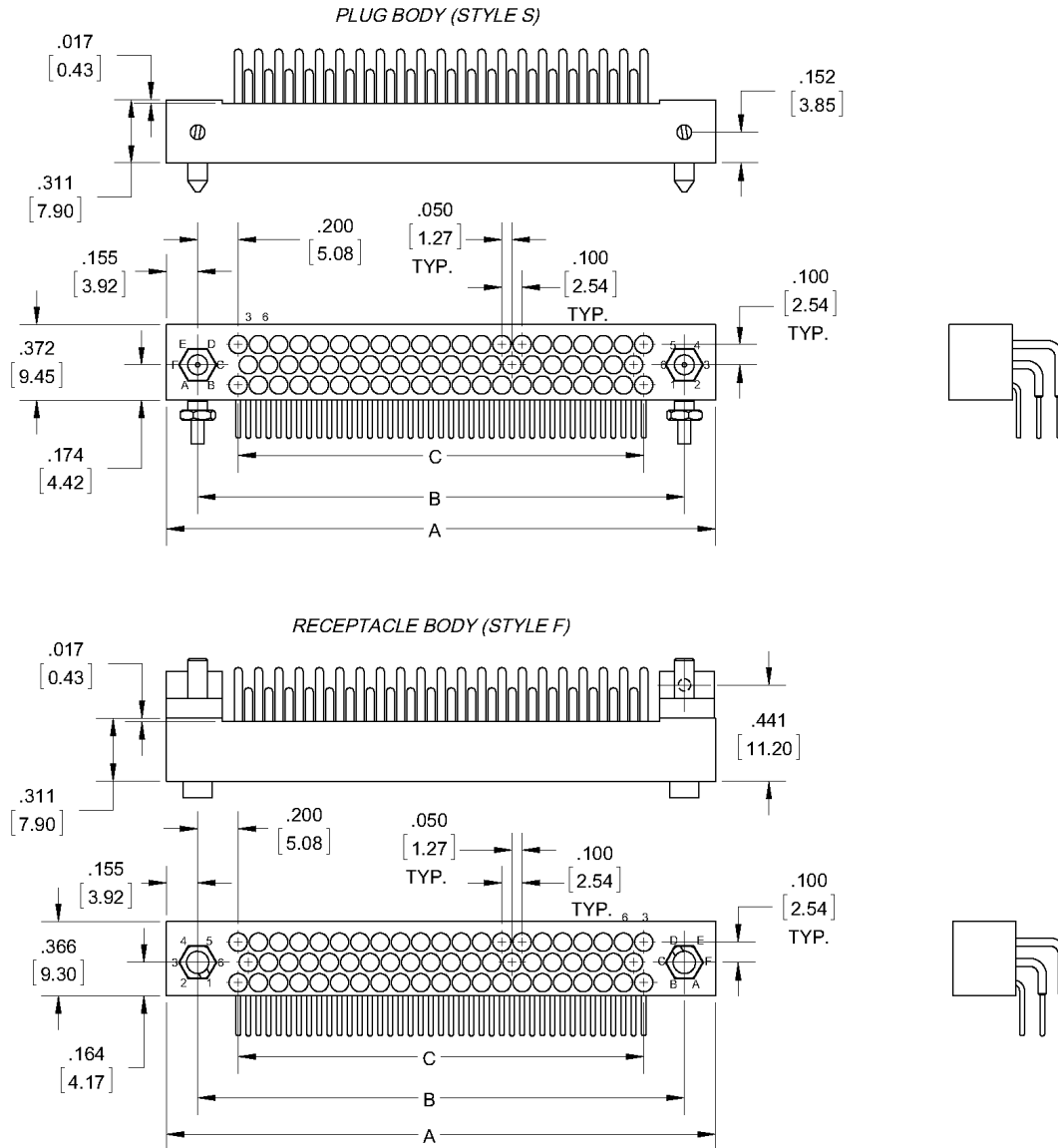

REFER TO APPENDIX FOR TERMINATION DETAILS, HARDWARE STYLES, AND PWB PATTERNS

No. of Contacts	A	B	C
62	2.707 [68.75]	2.400 [60.96]	2.000 [50.80]
80	3.307 [84.00]	3.000 [76.20]	2.600 [66.04]
98	3.907 [99.24]	3.600 [91.44]	3.200 [81.28]

**SOCKET, COMPLIANT
STYLE FV
STYLE SV**

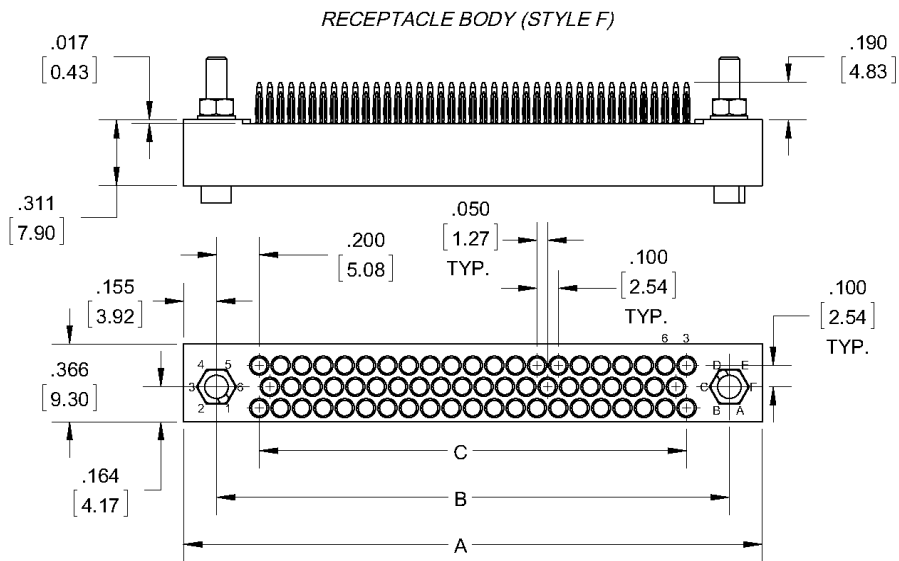
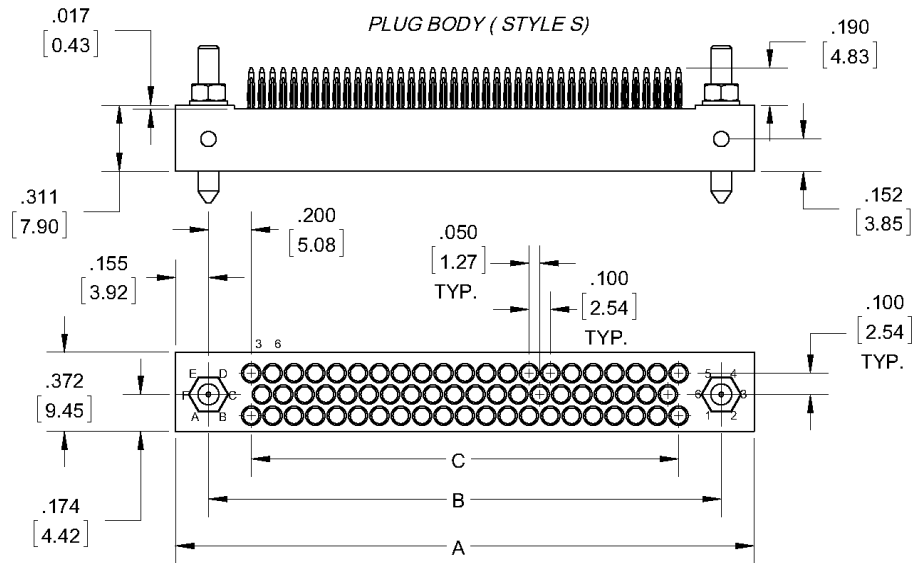

REFER TO APPENDIX FOR TERMINATION DETAILS, HARDWARE STYLES, AND PWB PATTERNS

No. of Contacts	A	B	C
62	2.707 [68.75]	2.400 [60.96]	2.000 [50.80]
80	3.307 [84.00]	3.000 [76.20]	2.600 [66.04]
98	3.907 [99.24]	3.600 [91.44]	3.200 [81.28]

PIN, STRAIGHT STYLE MC, MD, MS, MW STYLE PC, PD, PS, PW

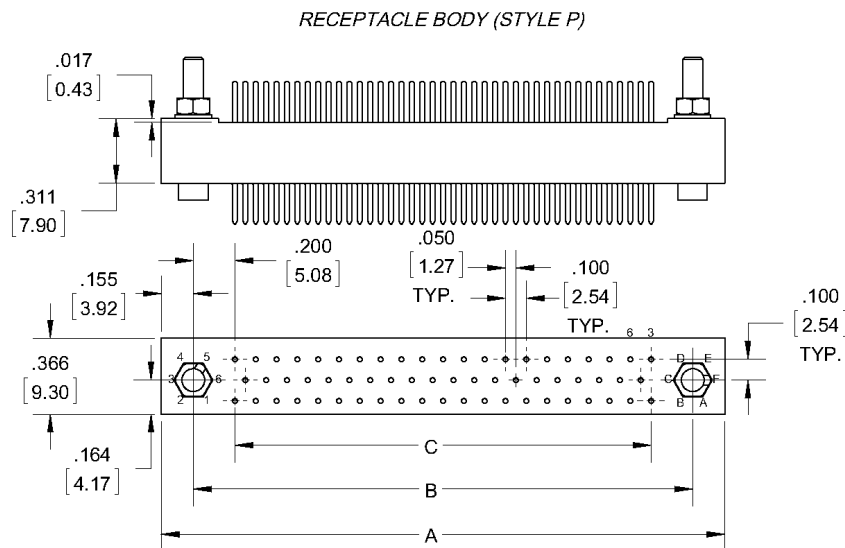
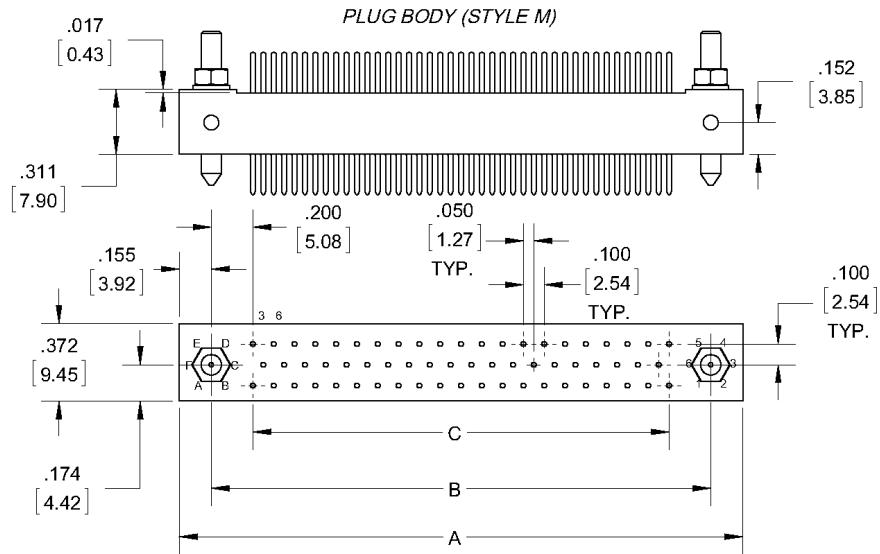

REFER TO APPENDIX FOR TERMINATION DETAILS, HARDWARE STYLES, AND PWB PATTERNS

No. of Contacts	A	B	C
62	2.707 [68.75]	2.400 [60.96]	2.000 [50.80]
80	3.307 [84.00]	3.000 [76.20]	2.600 [66.04]
98	3.907 [99.24]	3.600 [91.44]	3.200 [81.28]

PIN, RIGHT ANGLE
STYLE ME
STYLE PE

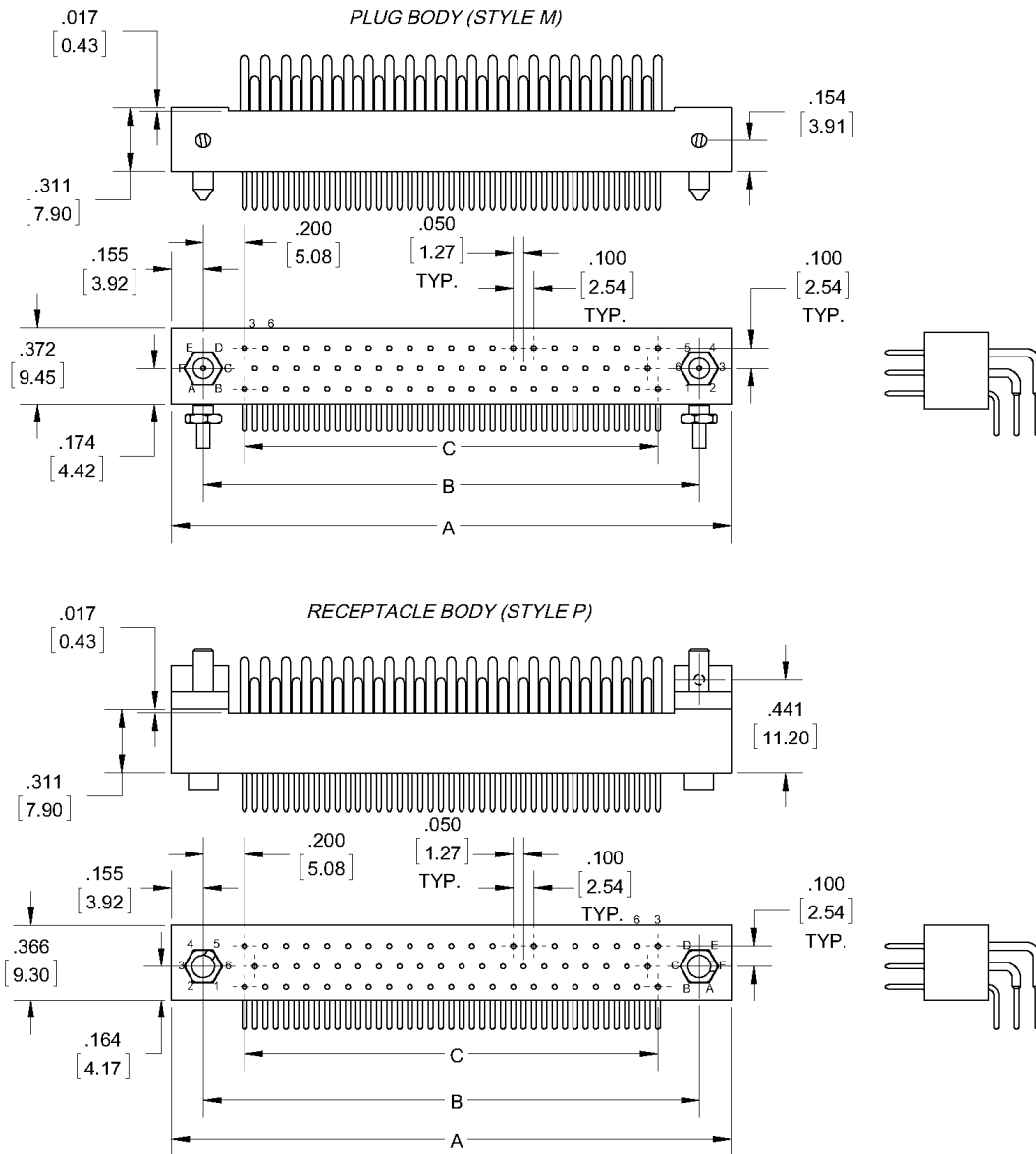

REFER TO APPENDIX FOR TERMINATION DETAILS, HARDWARE STYLES, AND PWB PATTERNS

No. of Contacts	A	B	C
62	2.707 [68.75]	2.400 [60.96]	2.000 [50.80]
80	3.307 [84.00]	3.000 [76.20]	2.600 [66.04]
98	3.907 [99.24]	3.600 [91.44]	3.200 [81.28]

PIN, COMPLIANT STYLE MV STYLE PV

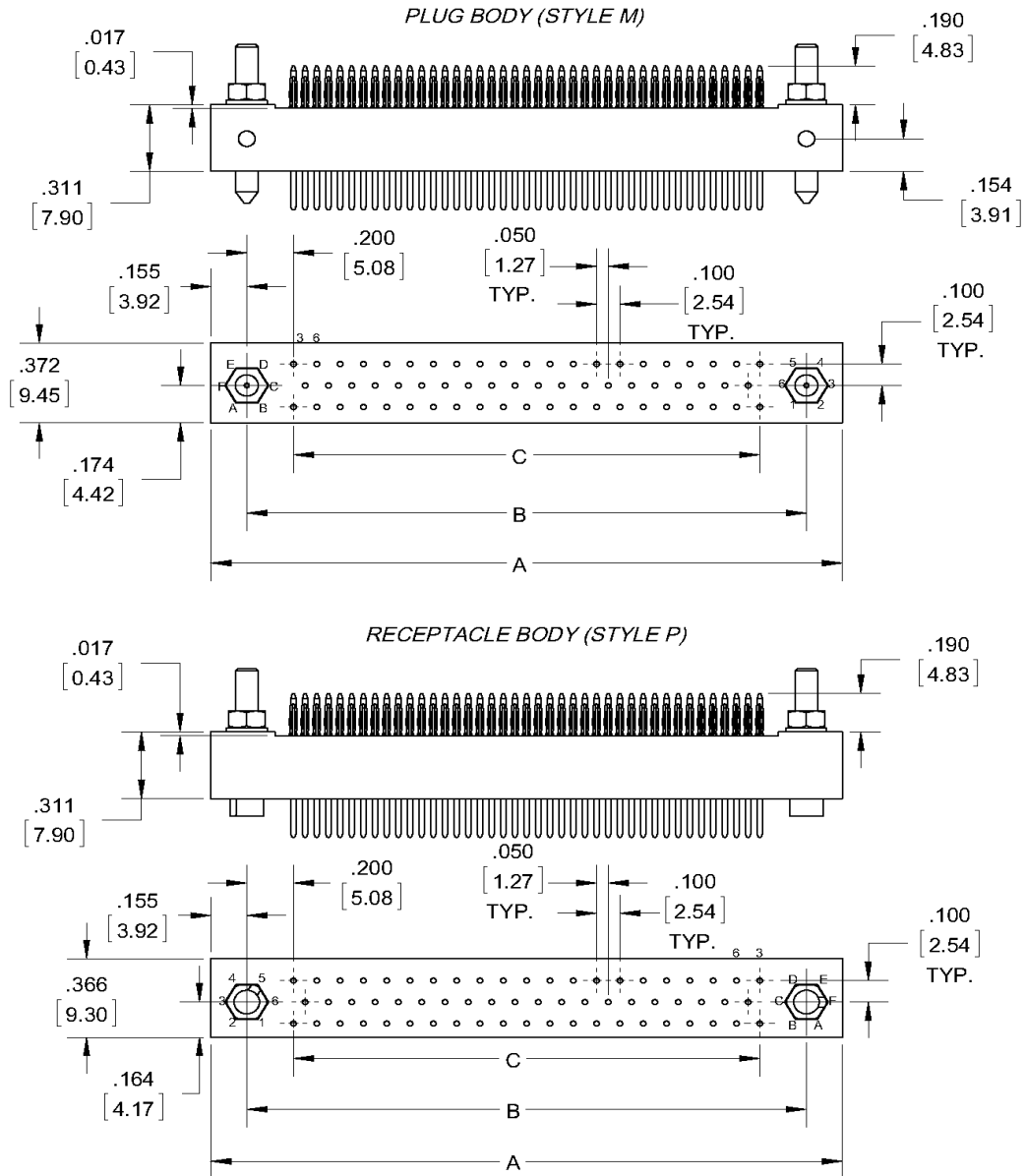

REFER TO APPENDIX FOR TERMINATION DETAILS, HARDWARE STYLES, AND PWB PATTERNS

No. of Contacts	A	B	C
62	2.707 [68.75]	2.400 [60.96]	2.000 [50.80]
80	3.307 [84.00]	3.000 [76.20]	2.600 [66.04]
98	3.907 [99.24]	3.600 [91.44]	3.200 [81.28]

SOCKET, STRAIGHT
STYLE 126 FC, FD, FS, FW
STYLE 126 SC, SD, SS, SW

PLUG BODY (STYLE S)

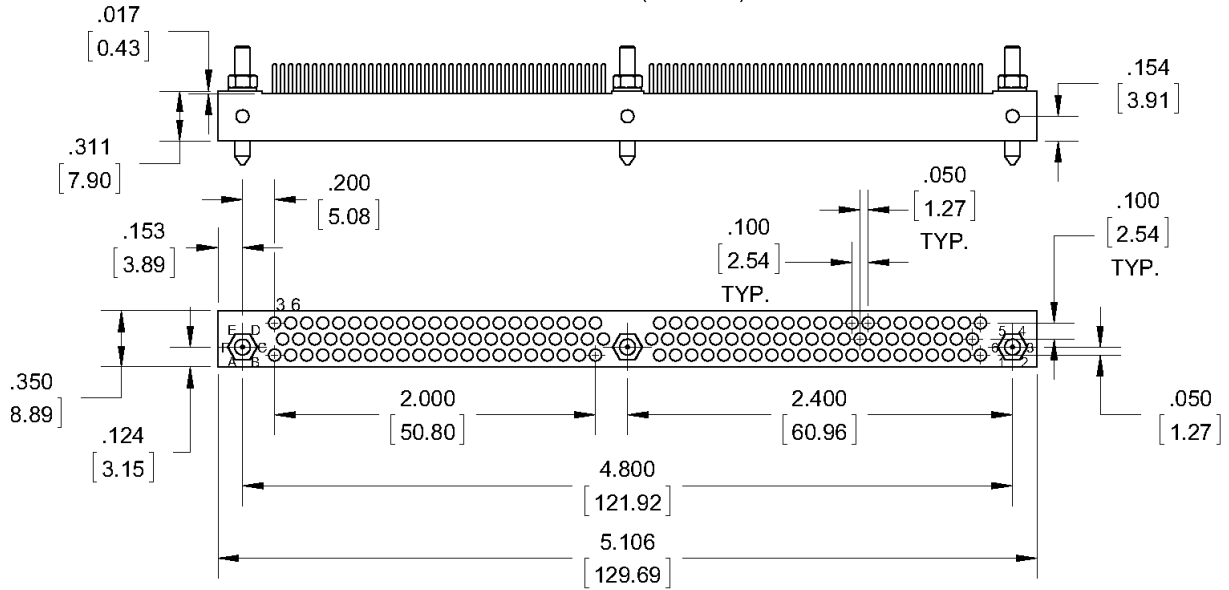

RECEPTACLE BODY (STYLE F)

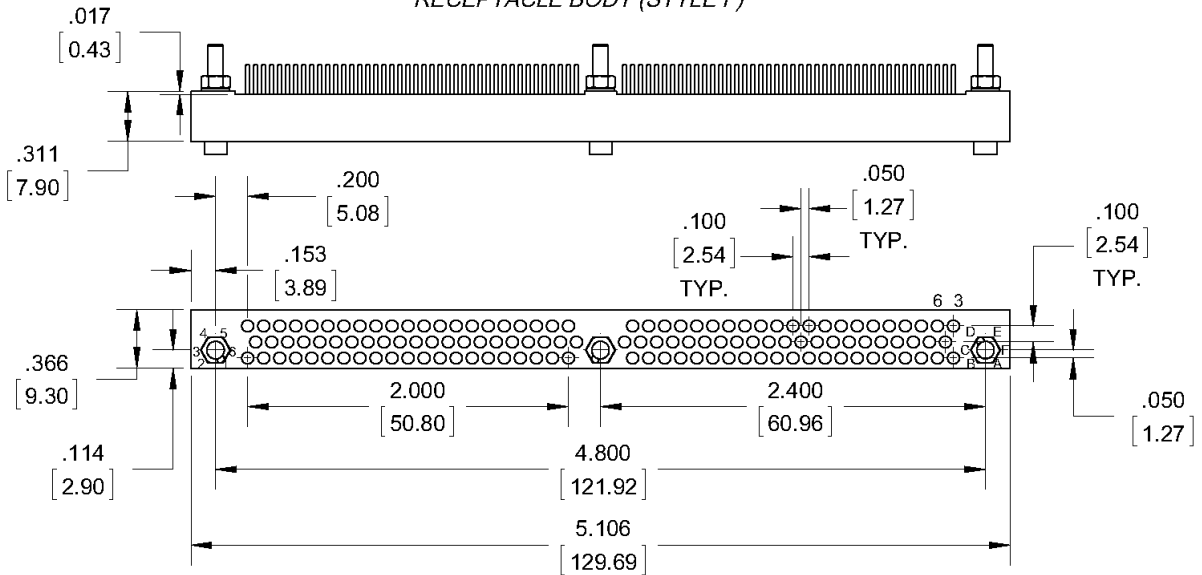

REFER TO APPENDIX FOR TERMINATION DETAILS, HARDWARE STYLES, AND PWB PATTERNS

SOCKET, RIGHT ANGLE
STYLE 126 FE
STYLE 126 SE

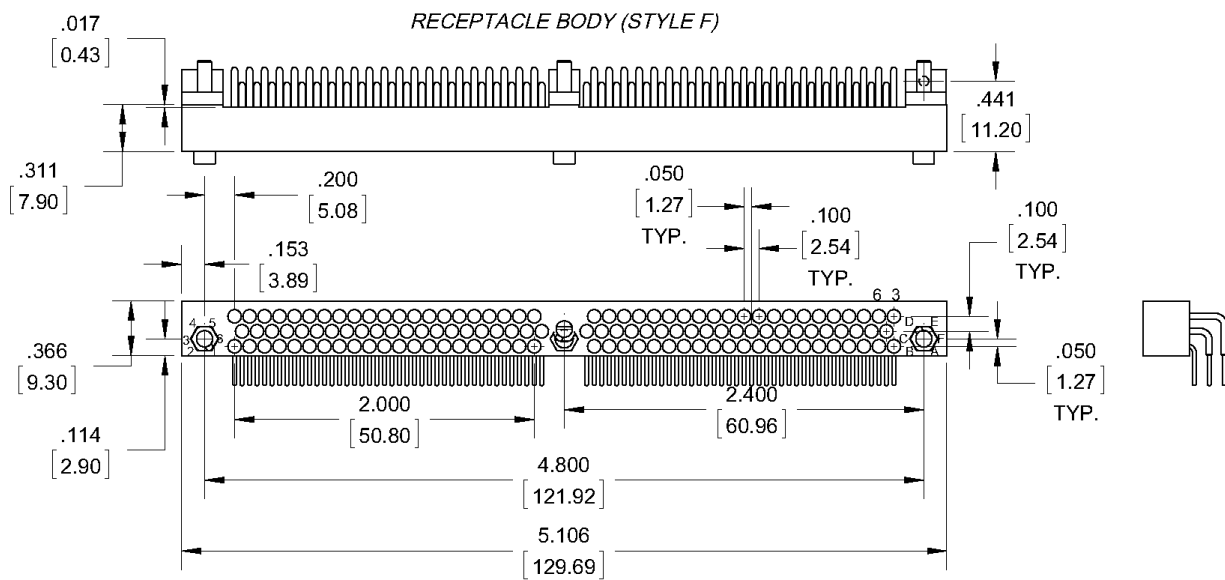
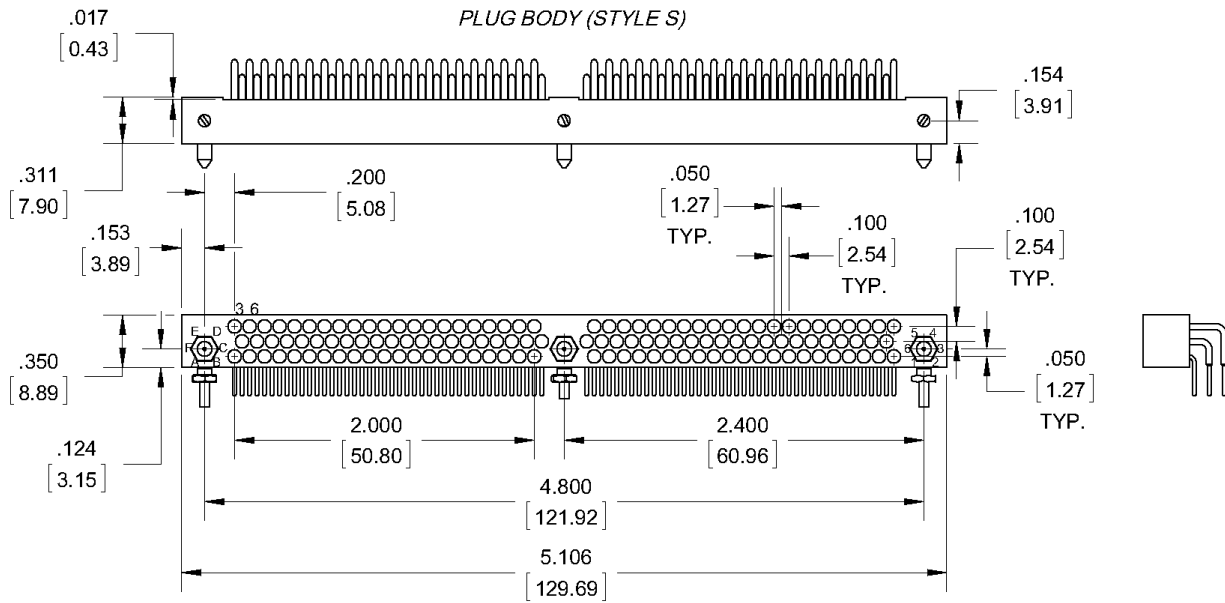

**REFER TO APPENDIX FOR TERMINATION DETAILS, HARDWARE
 STYLES, AND PWB PATTERNS**

PIN, STRAIGHT
STYLE 126 MC, MD, MS, MW
STYLE 126 PC, PD, PS, PW

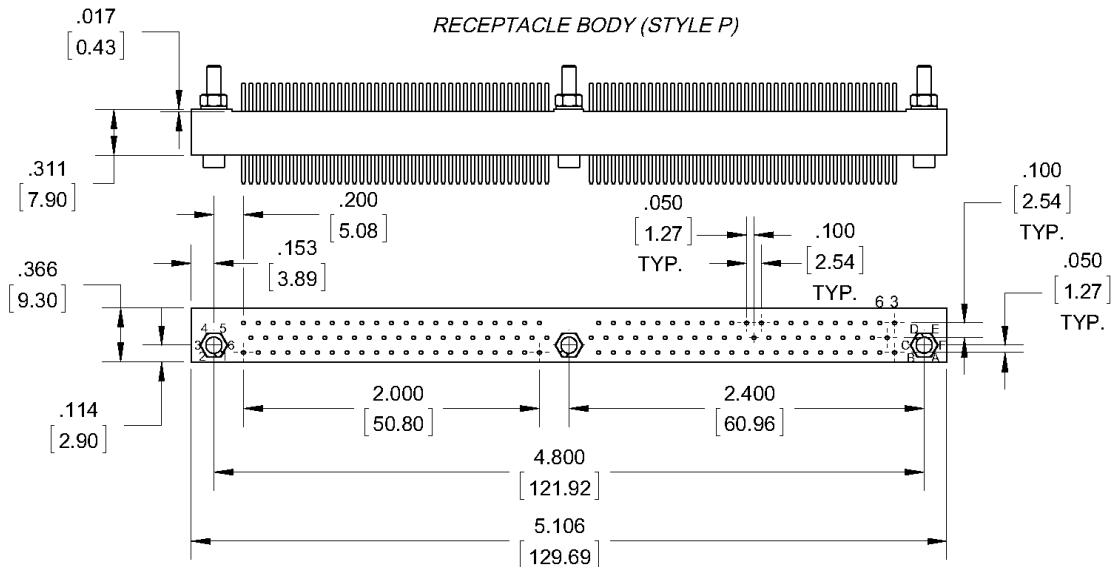
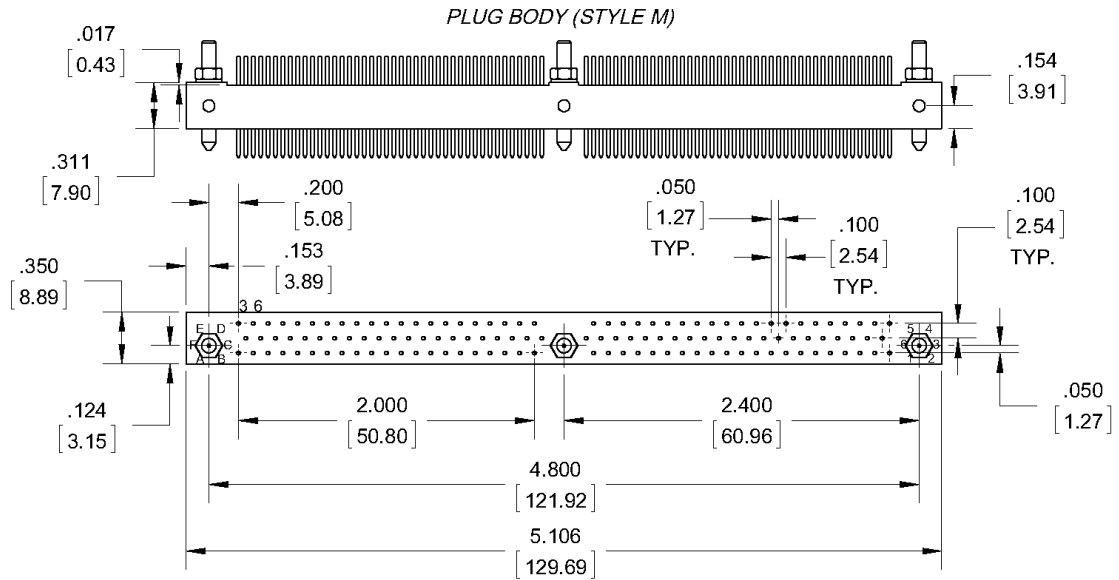

REFER TO APPENDIX FOR TERMINATION DETAILS, HARDWARE STYLES, AND PWB PATTERNS

SOCKET, STRAIGHT
STYLE 160 FC, FD, FS, FW
STYLE 160 SC, SD, SS, SW

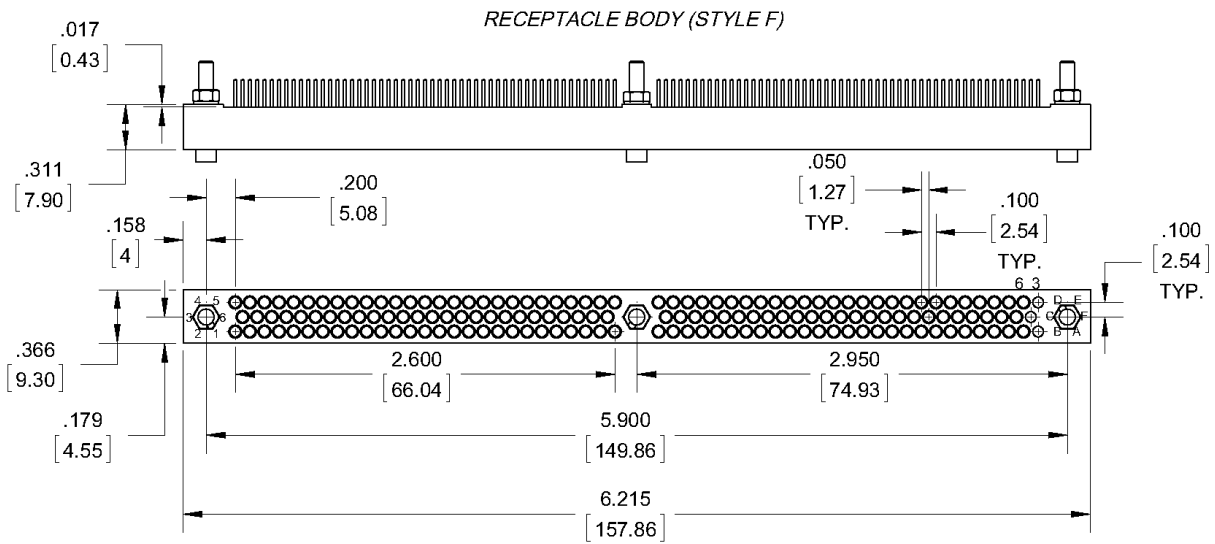
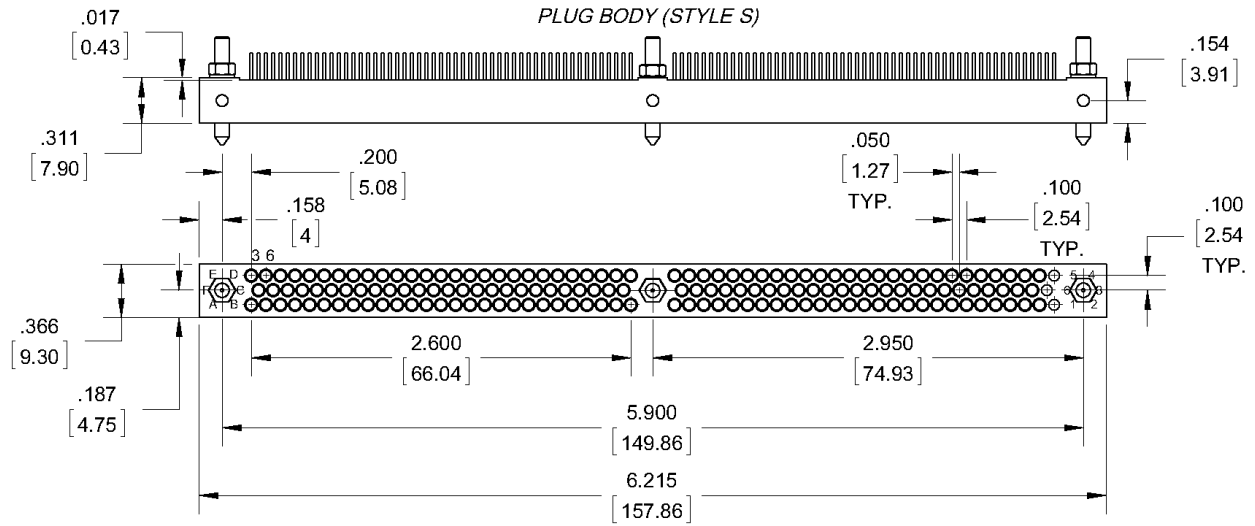

**REFER TO APPENDIX FOR TERMINATION DETAILS, HARDWARE
 STYLES, AND PWB PATTERNS**

SOCKET, COMPLIANT
STYLE 160 FV
STYLE 160 SV

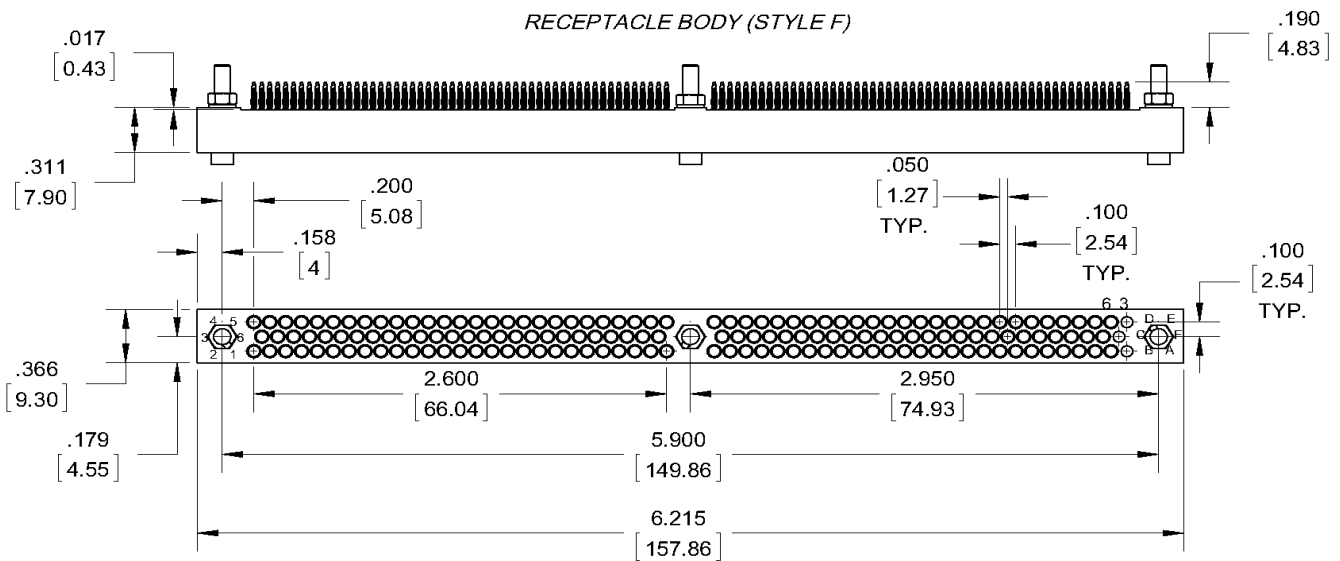
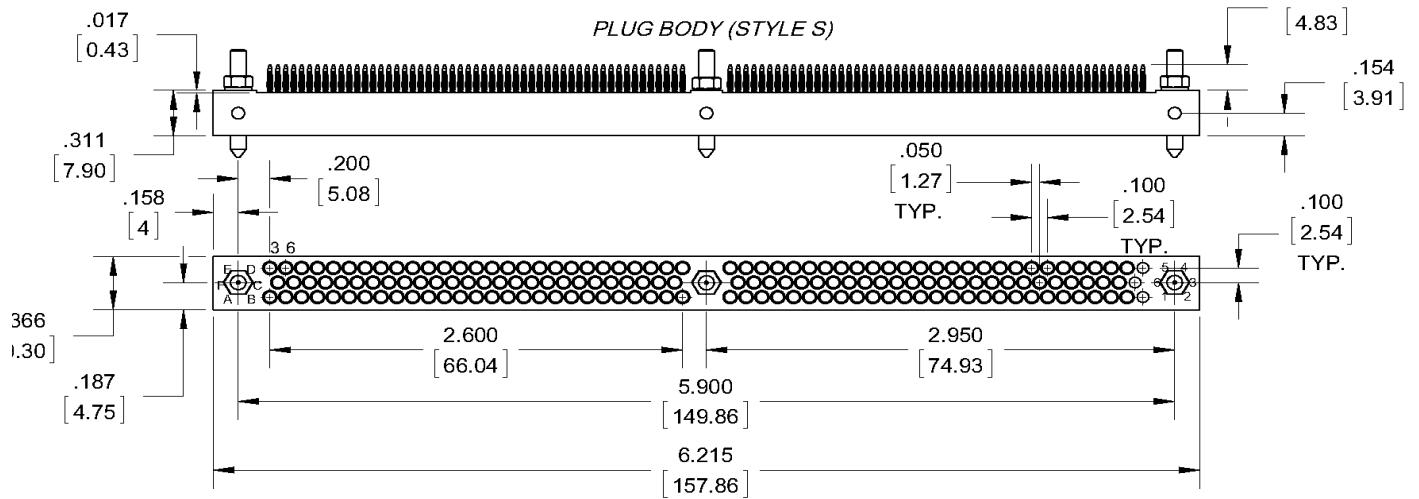

**REFER TO APPENDIX FOR TERMINATION DETAILS, HARDWARE
 STYLES, AND PWB PATTERNS**

PIN, STRAIGHT
STYLE 160 MC, MD, MS, MW
STYLE 160 PC, PD, PS, PW

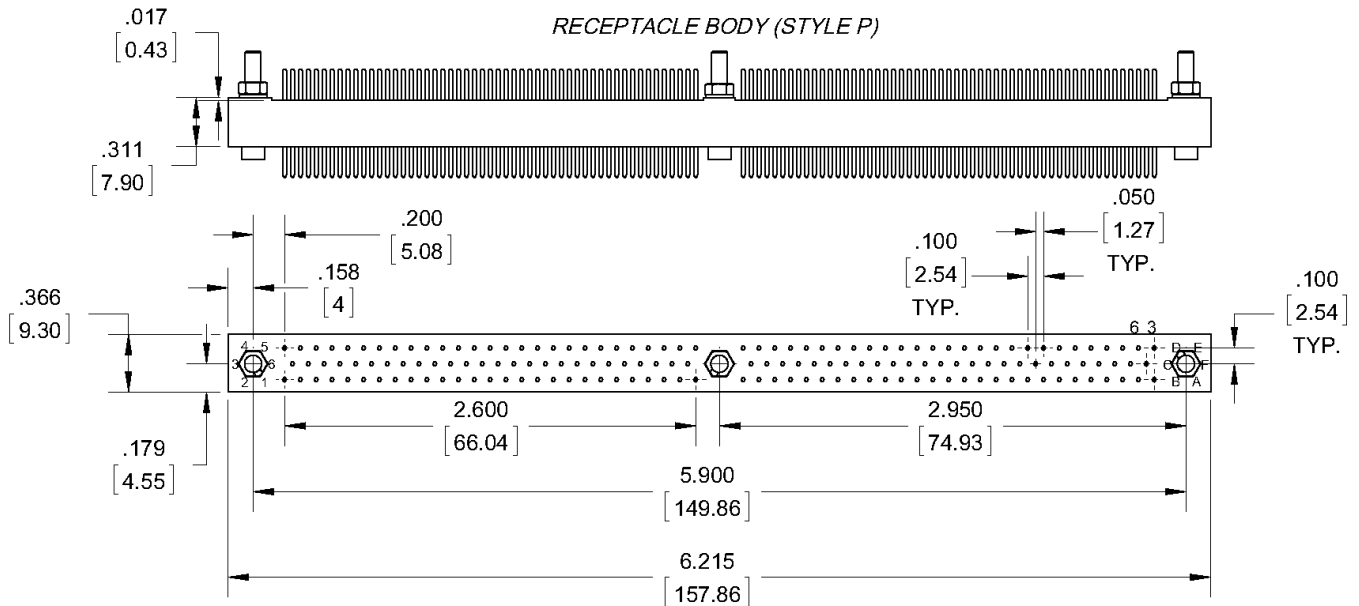
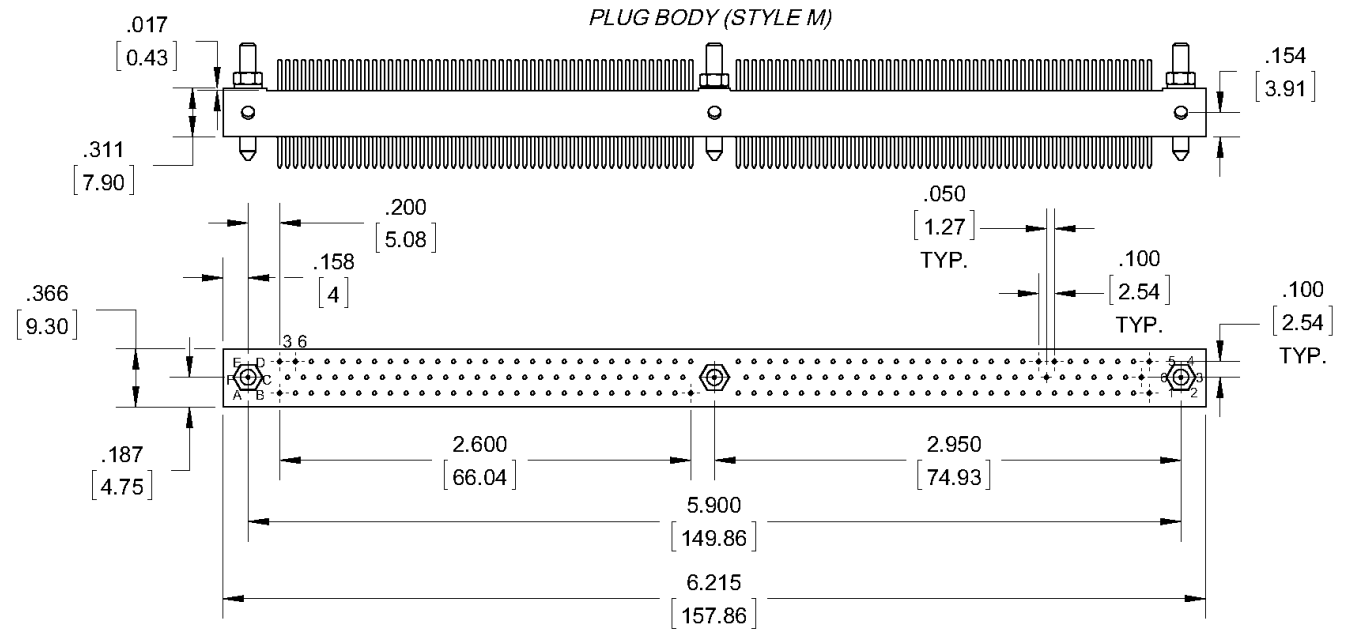

REFER TO APPENDIX FOR TERMINATION DETAILS, HARDWARE STYLES, AND PWB PATTERNS

**SOCKET, FRONT REMOVABLE, STRAIGHT
STYLE 160 FD, FW**

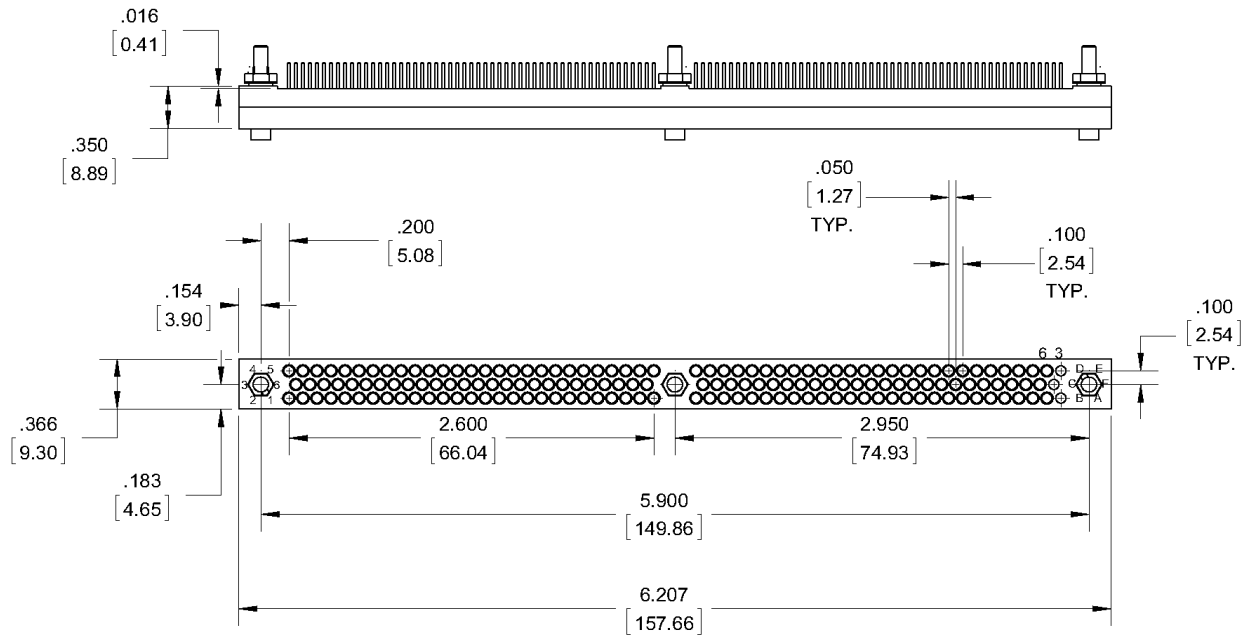

**ONLY AVAILABLE WITH HARDWARE STYLE POLARIZED GUIDES WITH MOUNTING STUD (B)
ONLY AVAILABLE WITH TERMINATION STYLE STRAIGHT DIP SOLDER (D) AND WIRE WRAP (W)**

**REFER TO APPENDIX FOR TERMINATION DETAILS, HARDWARE
STYLES, AND PWB PATTERNS**

ORDERING CHART 4 & 5 - Row

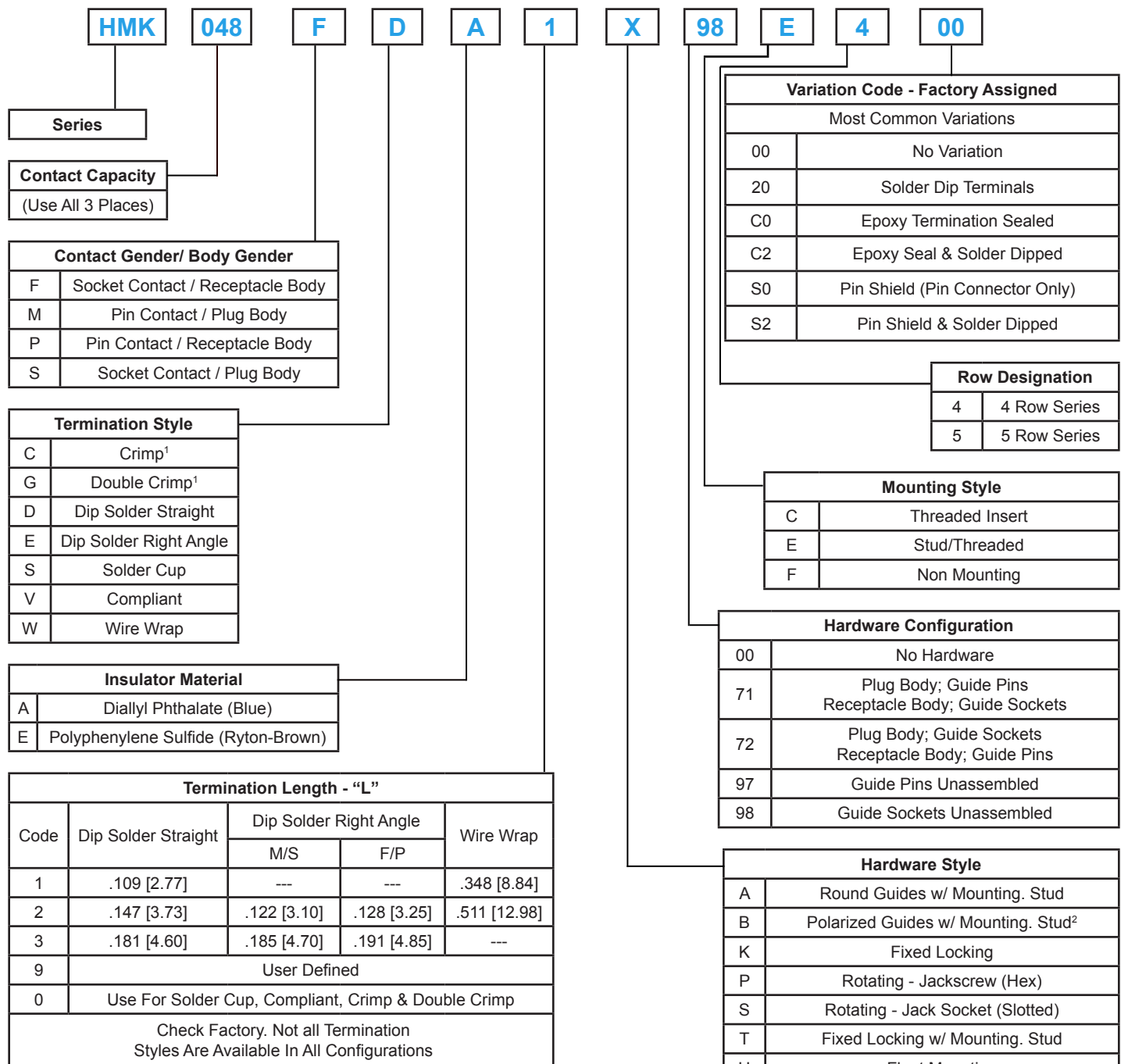
Notes:

1. Crimp contacts supplied loose with connector housing
2. Keying is available in 36 styles. If not specified, will be supplied in position C3. The user can change the keying position

SOCKET, STRAIGHT
STYLE FC, FD, FS, FW
***STYLE SC, SD, SS, SW**

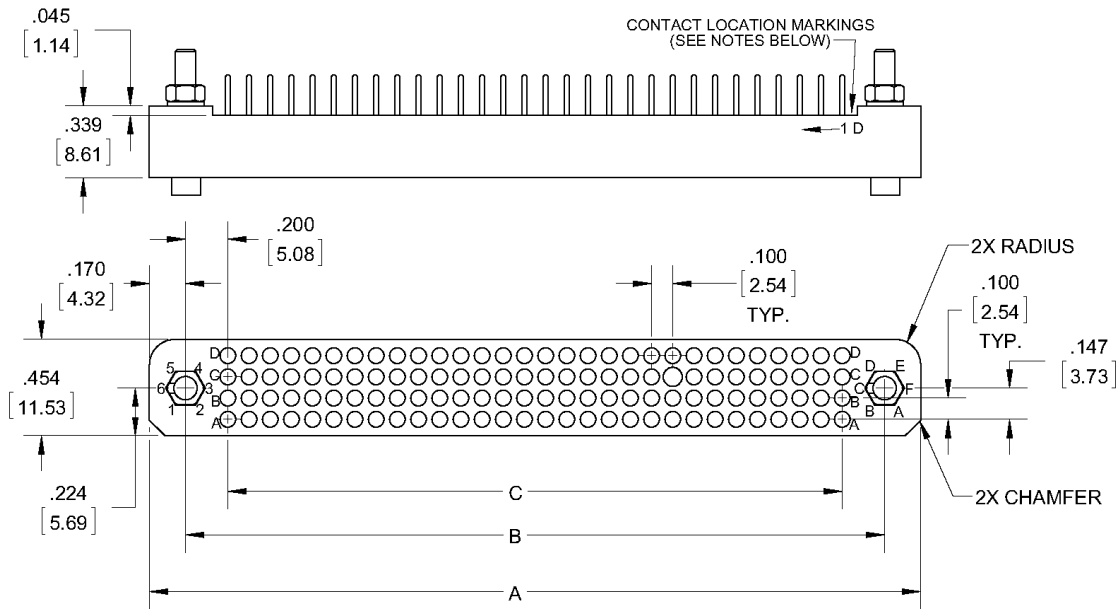

No. of Contacts	A	B	C
48	1.840 [46.74]	1.500 [38.10]	1.100 [27.94]
68	2.340 [59.44]	2.000 [50.80]	1.600 [40.64]
80	2.640 [67.06]	2.300 [58.42]	1.900 [48.26]
96	3.040 [77.22]	2.700 [68.58]	2.300 [58.42]
100	3.140 [79.76]	2.800 [71.12]	2.400 [60.96]
108	3.340 [84.84]	3.000 [76.20]	2.600 [66.04]
120	3.640 [92.46]	3.300 [83.82]	2.900 [73.66]
128	3.840 [97.54]	3.500 [88.90]	3.100 [78.74]
136	4.040 [102.62]	3.700 [93.98]	3.300 [83.82]
160	4.640 [117.86]	4.300 [109.22]	3.900 [99.06]
184	5.240 [133.10]	4.900 [124.46]	4.500 [114.30]
196	5.540 [140.72]	5.200 [132.08]	4.800 [121.92]

***CONTACT LOCATION MARKING NOTES**
 - PLUG (STYLE S) HAS MARKINGS ON CHAMFER SIDE
 - RECEPTACLE (STYLE F) HAS MARKINGS ON RADIUS SIDE
 - FOR REVERSE SEE ORDERING CHART

**REFER TO APPENDIX FOR TERMINATION DETAILS,
 HARDWARE STYLES, AND PWB PATTERNS**

SOCKET, RIGHT ANGLE STYLE FE *STYLE SE

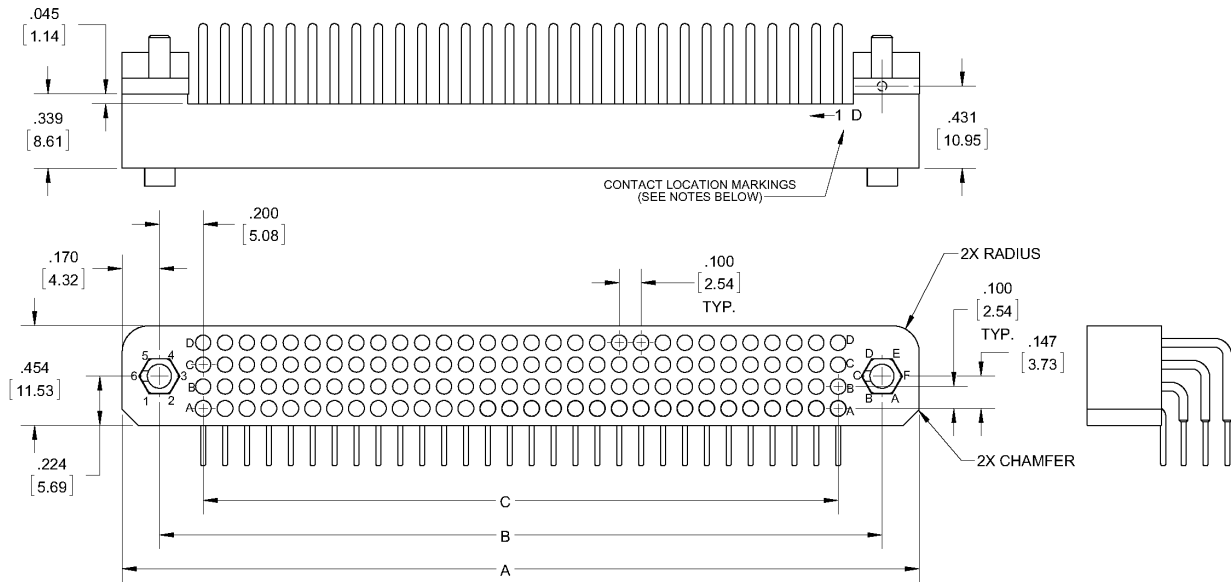

No. of Contacts	A	B	C
48	1.840 [46.74]	1.500 [38.10]	1.100 [27.94]
68	2.340 [59.44]	2.000 [50.80]	1.600 [40.64]
80	2.640 [67.06]	2.300 [58.42]	1.900 [48.26]
96	3.040 [77.22]	2.700 [68.58]	2.300 [58.42]
100	3.140 [79.76]	2.800 [71.12]	2.400 [60.96]
108	3.340 [84.84]	3.000 [76.20]	2.600 [66.04]
120	3.640 [92.46]	3.300 [83.82]	2.900 [73.66]
128	3.840 [97.54]	3.500 [88.90]	3.100 [78.74]
136	4.040 [102.62]	3.700 [93.98]	3.300 [83.82]
160	4.640 [117.86]	4.300 [109.22]	3.900 [99.06]
184	5.240 [133.10]	4.900 [124.46]	4.500 [114.30]
196	5.540 [140.72]	5.200 [132.08]	4.800 [121.92]

***CONTACT LOCATION MARKING NOTES**
 - PLUG (STYLE S) HAS MARKINGS ON CHAMFER SIDE
 - RECEPTACLE (STYLE F) HAS MARKINGS ON RADIUS SIDE
 - FOR REVERSE SEE ORDERING CHART

**REFER TO APPENDIX FOR TERMINATION DETAILS,
 HARDWARE STYLES, AND PWB PATTERNS**

**SOCKET, COMPLIANT
STYLE FV
*STYLE SV**

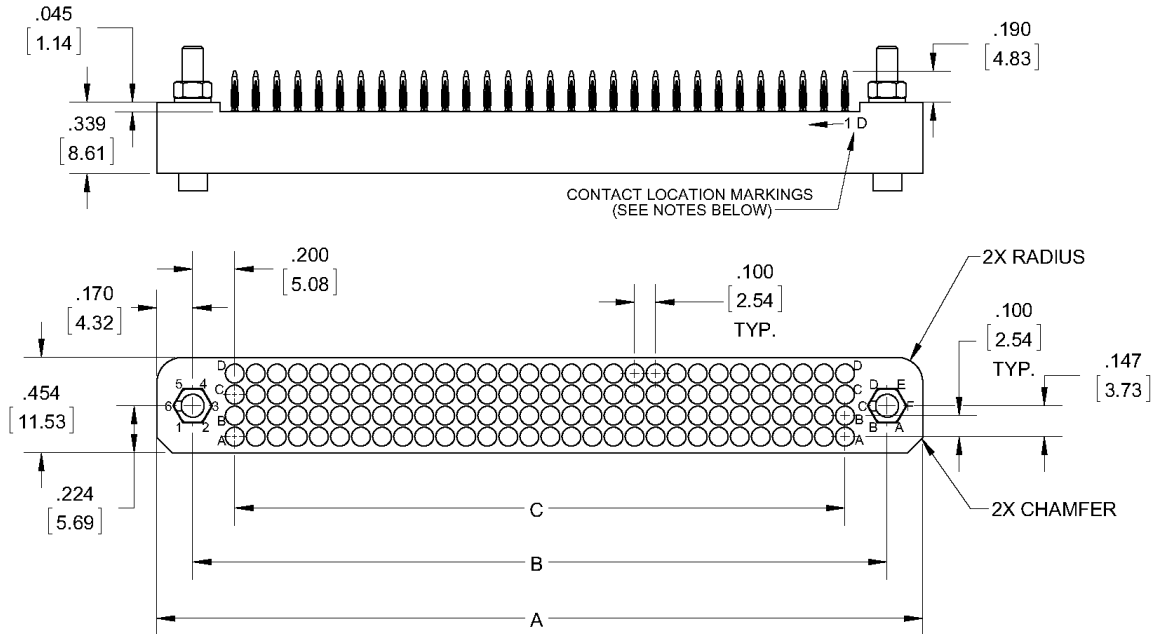

No. of Contacts	A	B	C
48	1.840 [46.74]	1.500 [38.10]	1.100 [27.94]
68	2.340 [59.44]	2.000 [50.80]	1.600 [40.64]
80	2.640 [67.06]	2.300 [58.42]	1.900 [48.26]
96	3.040 [77.22]	2.700 [68.58]	2.300 [58.42]
100	3.140 [79.76]	2.800 [71.12]	2.400 [60.96]
108	3.340 [84.84]	3.000 [76.20]	2.600 [66.04]
120	3.640 [92.46]	3.300 [83.82]	2.900 [73.66]
128	3.840 [97.54]	3.500 [88.90]	3.100 [78.74]
136	4.040 [102.62]	3.700 [93.98]	3.300 [83.82]
160	4.640 [117.86]	4.300 [109.22]	3.900 [99.06]
184	5.240 [133.10]	4.900 [124.46]	4.500 [114.30]
196	5.540 [140.72]	5.200 [132.08]	4.800 [121.92]

***CONTACT LOCATION MARKING NOTES**
 - PLUG (STYLE S) HAS MARKINGS ON CHAMFER SIDE
 - RECEPTACLE (STYLE F) HAS MARKINGS ON RADIUS SIDE
 - FOR REVERSE SEE ORDERING CHART

REFER TO APPENDIX FOR TERMINATION DETAILS,
 HARDWARE STYLES, AND PWB PATTERNS

PIN, STRAIGHT STYLE MC, MD, MS, MW *STYLE PC, PD, PS, PW

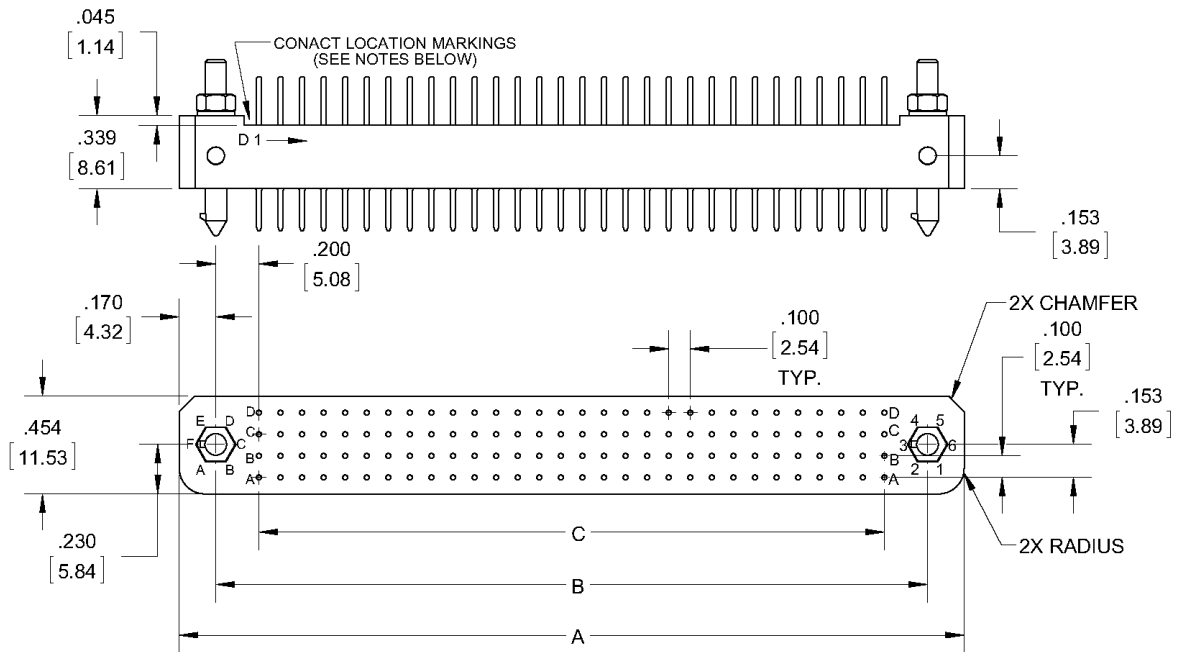

No. of Contacts	A	B	C
48	1.840 [46.74]	1.500 [38.10]	1.100 [27.94]
68	2.340 [59.44]	2.000 [50.80]	1.600 [40.64]
80	2.640 [67.06]	2.300 [58.42]	1.900 [48.26]
96	3.040 [77.22]	2.700 [68.58]	2.300 [58.42]
100	3.140 [79.76]	2.800 [71.12]	2.400 [60.96]
108	3.340 [84.84]	3.000 [76.20]	2.600 [66.04]
120	3.640 [92.46]	3.300 [83.82]	2.900 [73.66]
128	3.840 [97.54]	3.500 [88.90]	3.100 [78.74]
136	4.040 [102.62]	3.700 [93.98]	3.300 [83.82]
160	4.640 [117.86]	4.300 [109.22]	3.900 [99.06]
184	5.240 [133.10]	4.900 [124.46]	4.500 [114.30]
196	5.540 [140.72]	5.200 [132.08]	4.800 [121.92]

***CONTACT LOCATION MARKING NOTES**
 - PLUG (STYLE M) HAS MARKINGS ON CHAMFER SIDE
 - RECEPTACLE (STYLE P) HAS MARKINGS ON RADIUS SIDE
 - FOR REVERSE SEE ORDERING CHART

REFER TO APPENDIX FOR TERMINATION DETAILS,
 HARDWARE STYLES, AND PWB PATTERNS

PIN, RIGHT ANGLE
STYLE ME
***STYLE PE**

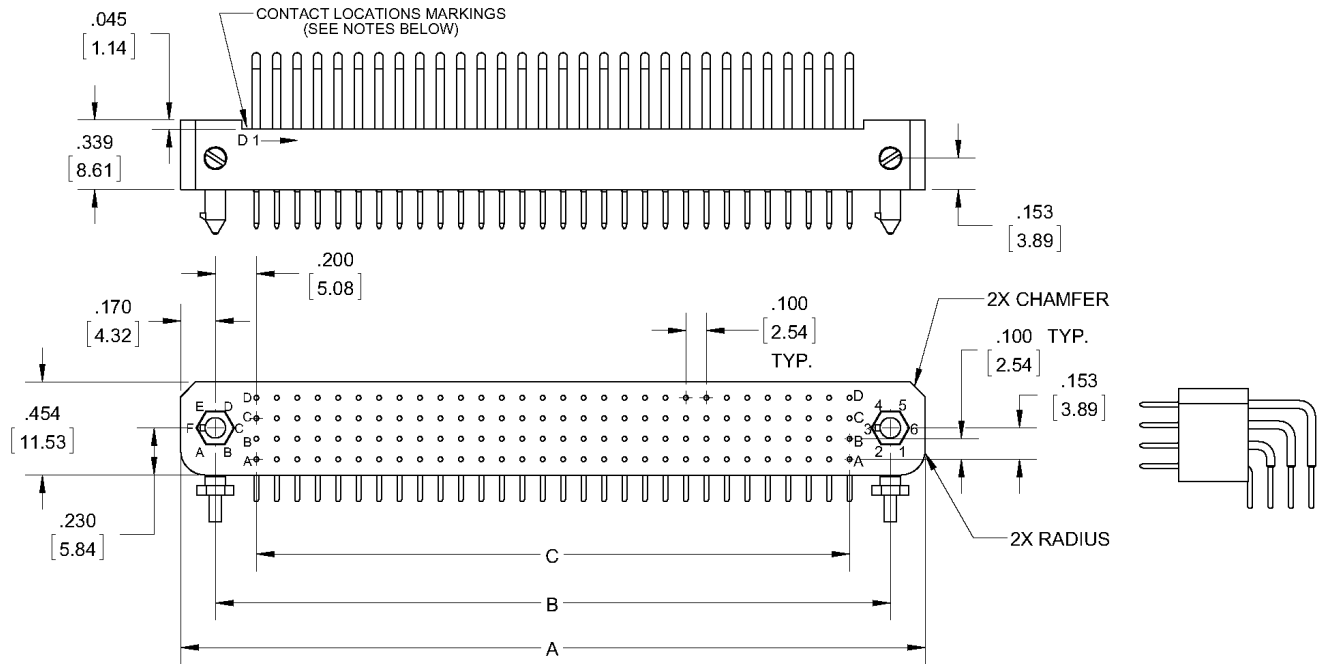

No. of Contacts	A	B	C
48	1.840 [46.74]	1.500 [38.10]	1.100 [27.94]
68	2.340 [59.44]	2.000 [50.80]	1.600 [40.64]
80	2.640 [67.06]	2.300 [58.42]	1.900 [48.26]
96	3.040 [77.22]	2.700 [68.58]	2.300 [58.42]
100	3.140 [79.76]	2.800 [71.12]	2.400 [60.96]
108	3.340 [84.84]	3.000 [76.20]	2.600 [66.04]
120	3.640 [92.46]	3.300 [83.82]	2.900 [73.66]
128	3.840 [97.54]	3.500 [88.90]	3.100 [78.74]
136	4.040 [102.62]	3.700 [93.98]	3.300 [83.82]
160	4.640 [117.86]	4.300 [109.22]	3.900 [99.06]
184	5.240 [133.10]	4.900 [124.46]	4.500 [114.30]
196	5.540 [140.72]	5.200 [132.08]	4.800 [121.92]

***CONTACT LOCATION MARKING NOTES**
 - PLUG (STYLE M) HAS MARKINGS ON CHAMFER SIDE
 - RECEPTACLE (STYLE P) HAS MARKINGS ON RADIUS SIDE
 - FOR REVERSE SEE ORDERING CHART

**REFER TO APPENDIX FOR TERMINATION DETAILS,
 HARDWARE STYLES, AND PWB PATTERNS**

PIN, COMPLIANT STYLE MV *STYLE PV

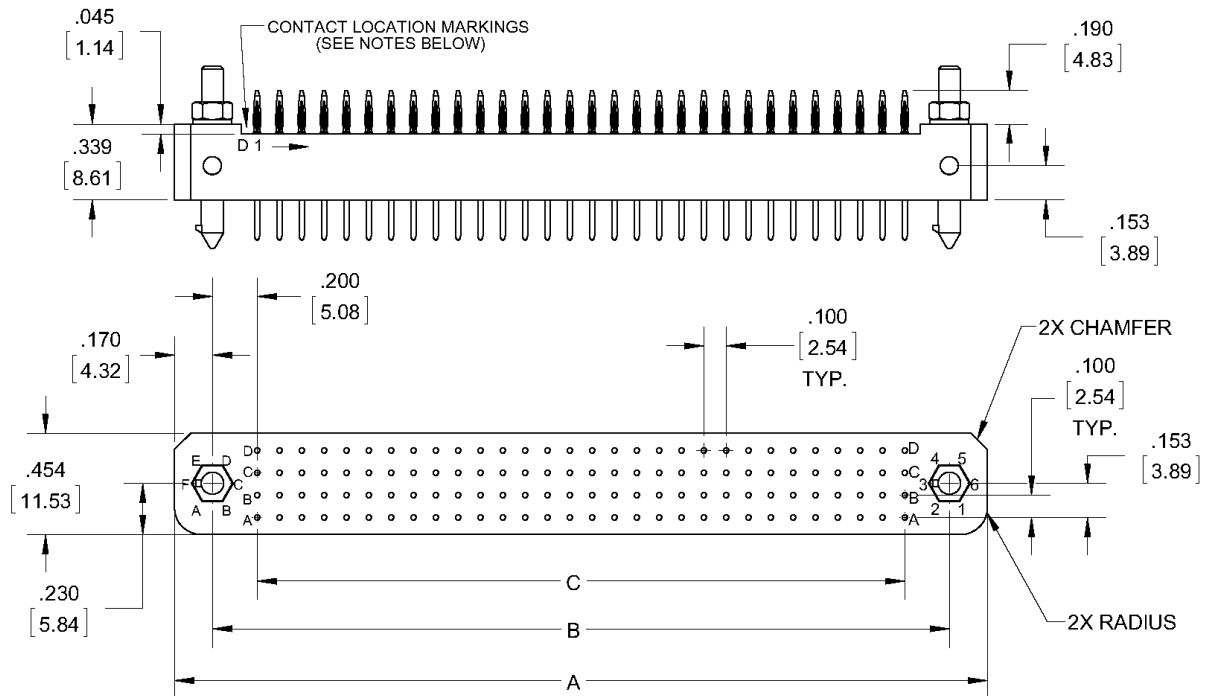

No. of Contacts	A	B	C
48	1.840 [46.74]	1.500 [38.10]	1.100 [27.94]
68	2.340 [59.44]	2.000 [50.80]	1.600 [40.64]
80	2.640 [67.06]	2.300 [58.42]	1.900 [48.26]
96	3.040 [77.22]	2.700 [68.58]	2.300 [58.42]
100	3.140 [79.76]	2.800 [71.12]	2.400 [60.96]
108	3.340 [84.84]	3.000 [76.20]	2.600 [66.04]
120	3.640 [92.46]	3.300 [83.82]	2.900 [73.66]
128	3.840 [97.54]	3.500 [88.90]	3.100 [78.74]
136	4.040 [102.62]	3.700 [93.98]	3.300 [83.82]
160	4.640 [117.86]	4.300 [109.22]	3.900 [99.06]
184	5.240 [133.10]	4.900 [124.46]	4.500 [114.30]
196	5.540 [140.72]	5.200 [132.08]	4.800 [121.92]

***CONTACT LOCATION MARKING NOTES**
 - PLUG (STYLE M) HAS MARKINGS ON CHAMFER SIDE
 - RECEPTACLE (STYLE P) HAS MARKINGS ON RADIUS SIDE
 - FOR REVERSE SEE ORDERING CHART

REFER TO APPENDIX FOR TERMINATION DETAILS,
 HARDWARE STYLES, AND PWB PATTERNS

SOCKET, STRAIGHT
STYLE FC, FD, FS, FW
***STYLE SC, SD, SS, SW**

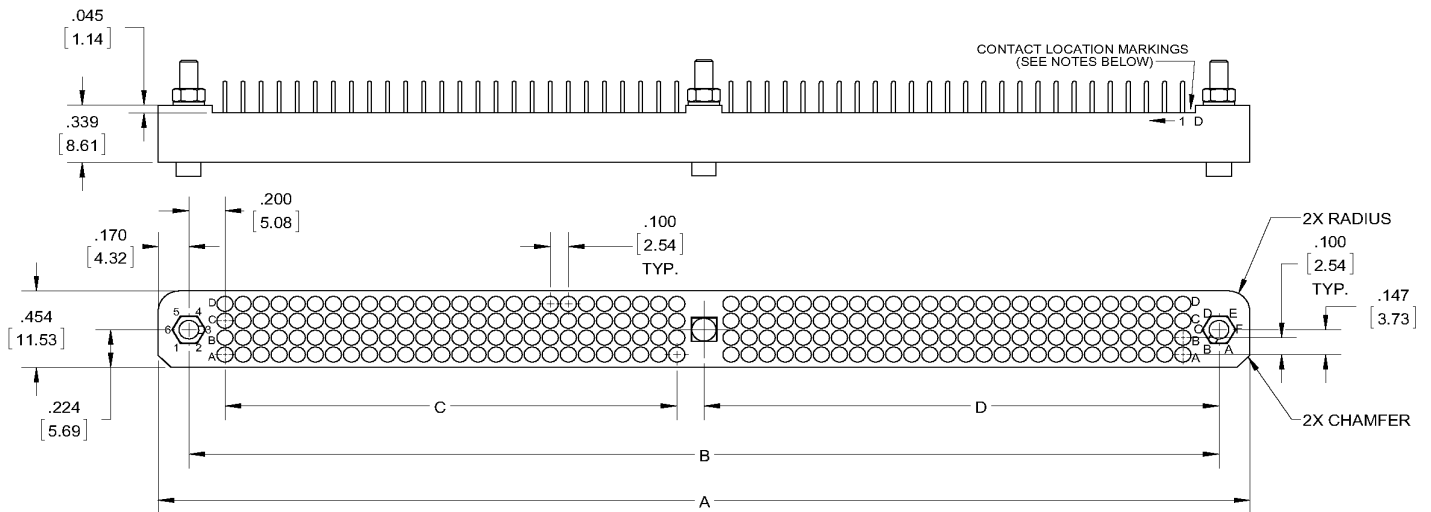

***CONTACT LOCATION MARKING NOTES**
 - PLUG (STYLE S) HAS MARKINGS ON CHAMFER SIDE
 - RECEPTACLE (STYLE F) HAS MARKINGS ON RADIUS SIDE
 - FOR REVERSE SEE ORDERING CHART

**REFER TO APPENDIX FOR TERMINATION DETAILS,
 HARDWARE STYLES, AND PWB PATTERNS**

No. of Contacts	A	B	C	D
208	6.040 [153.42]	5.700 [144.78]	2.500 [63.50]	2.850 [72.39]
240	6.840 [173.74]	6.500 [165.10]	2.900 [73.66]	3.250 [82.55]
264	7.438 [188.92]	7.100 [180.34]	3.200 [81.28]	3.550 [90.17]
352	9.640 [244.86]	9.300 [236.22]	4.300 [109.22]	4.650 [118.11]
392	10.640 [270.26]	10.300 [261.62]	4.800 [121.92]	5.150 [130.81]

SOCKET, RIGHT ANGLE
STYLE FE
***STYLE SE**

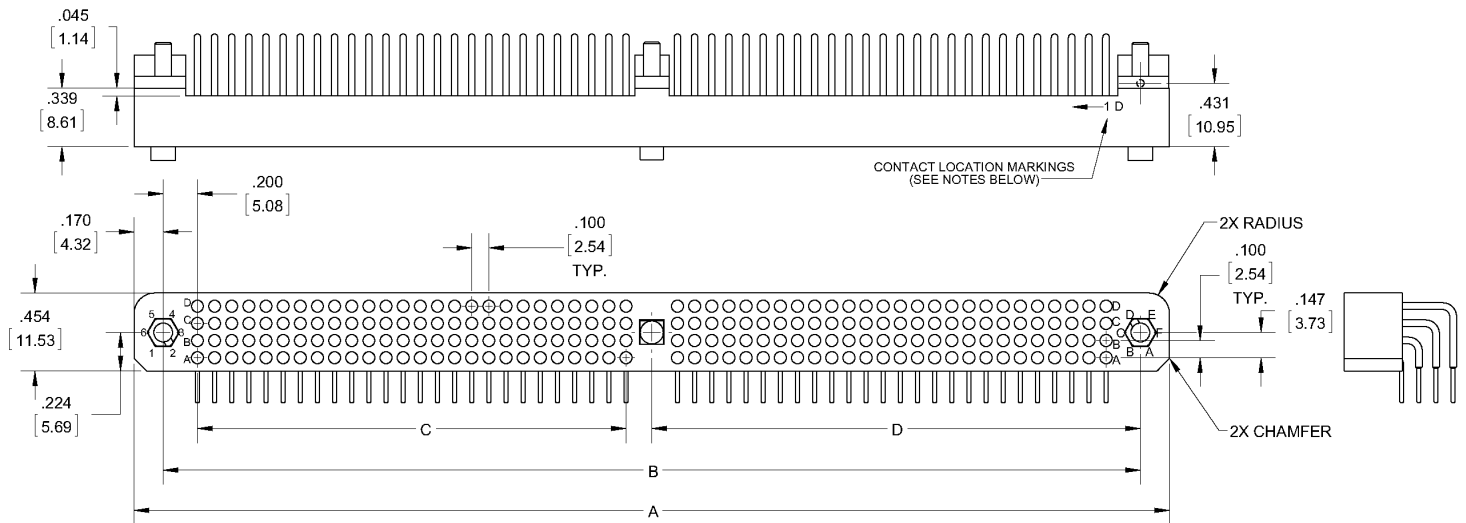

***CONTACT LOCATION MARKING NOTES**
 - PLUG (STYLE S) HAS MARKINGS ON CHAMFER SIDE
 - RECEPTACLE (STYLE F) HAS MARKINGS ON RADIUS SIDE
 - FOR REVERSE SEE ORDERING CHART

**REFER TO APPENDIX FOR TERMINATION DETAILS,
 HARDWARE STYLES, AND PWB PATTERNS**

No. of Contacts	A	B	C	D
208	6.040 [153.42]	5.700 [144.78]	2.500 [63.50]	2.850 [72.39]
240	6.840 [173.74]	6.500 [165.10]	2.900 [73.66]	3.250 [82.55]
264	7.438 [188.92]	7.100 [180.34]	3.200 [81.28]	3.550 [90.17]
352	9.640 [244.86]	9.300 [236.22]	4.300 [109.22]	4.650 [118.11]
392	10.640 [270.26]	10.300 [261.62]	4.800 [121.92]	5.150 [130.81]

**SOCKET, COMPLIANT
STYLE FV
*STYLE SV**

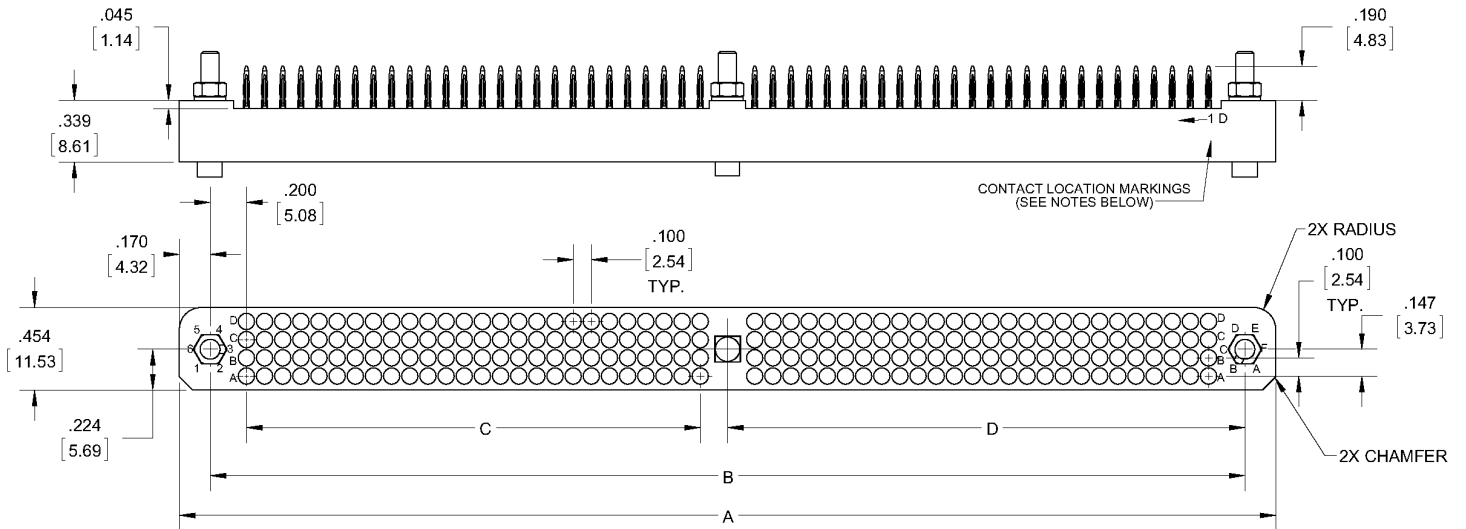

***CONTACT LOCATION MARKING NOTES**
 - PLUG (STYLE S) HAS MARKINGS ON CHAMFER SIDE
 - RECEPTACLE (STYLE F) HAS MARKINGS ON RADIUS SIDE
 - FOR REVERSE SEE ORDERING CHART

**REFER TO APPENDIX FOR TERMINATION DETAILS,
 HARDWARE STYLES, AND PWB PATTERNS**

No. of Contacts	A	B	C	D
208	6.040 [153.42]	5.700 [144.78]	2.500 [63.50]	2.850 [72.39]
240	6.840 [173.74]	6.500 [165.10]	2.900 [73.66]	3.250 [82.55]
264	7.438 [188.92]	7.100 [180.34]	3.200 [81.28]	3.550 [90.17]
352	9.640 [244.86]	9.300 [236.22]	4.300 [109.22]	4.650 [118.11]
392	10.640 [270.26]	10.300 [261.62]	4.800 [121.92]	5.150 [130.81]

PIN, STRAIGHT
STYLE MC, MD, MS, MW
***STYLE PC, PD, PS, PW**

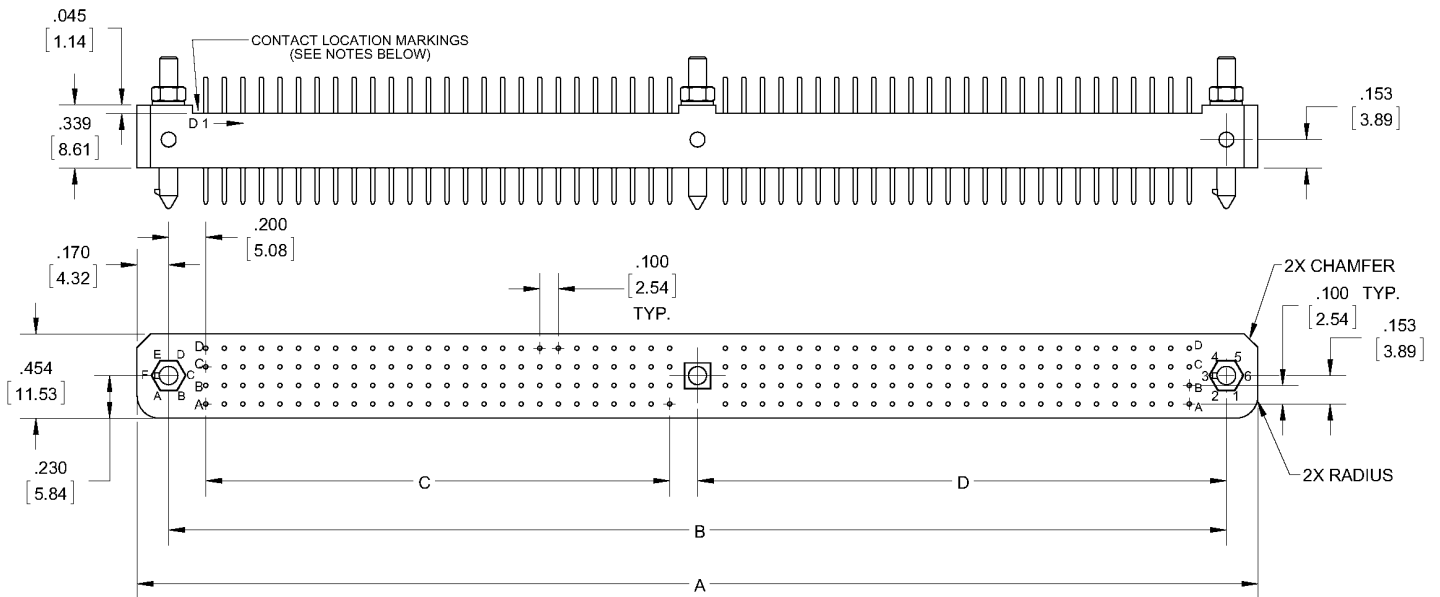

***CONTACT LOCATION MARKING NOTES**
 - PLUG (STYLE M) HAS MARKINGS ON CHAMFER SIDE
 - RECEPTACLE (STYLE P) HAS MARKINGS ON RADIUS SIDE
 - FOR REVERSE SEE ORDERING CHART

REFER TO APPENDIX FOR TERMINATION DETAILS,
 HARDWARE STYLES, AND PWB PATTERNS

No. of Contacts	A	B	C	D
208	6.040 [153.42]	5.700 [144.78]	2.500 [63.50]	2.850 [72.39]
240	6.840 [173.74]	6.500 [165.10]	2.900 [73.66]	3.250 [82.55]
264	7.438 [188.92]	7.100 [180.34]	3.200 [81.28]	3.550 [90.17]
352	9.640 [244.86]	9.300 [236.22]	4.300 [109.22]	4.650 [118.11]
392	10.640 [270.26]	10.300 [261.62]	4.800 [121.92]	5.150 [130.81]

**PIN, RIGHT ANGLE
STYLE ME
*STYLE PE**

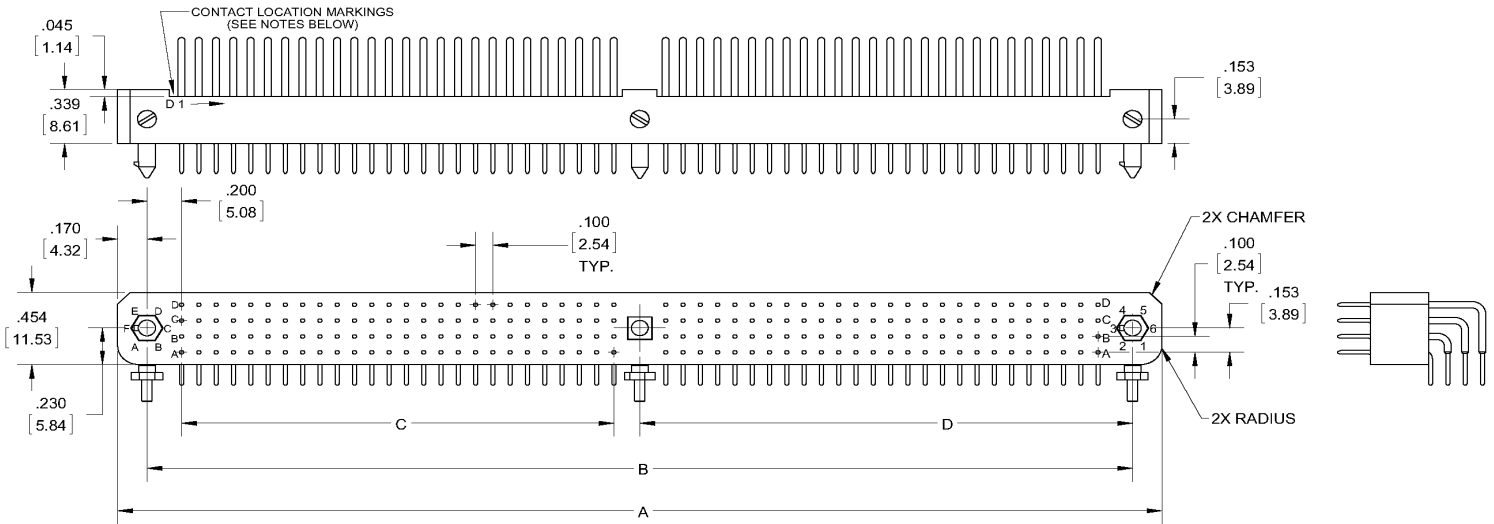

***CONTACT LOCATION MARKING NOTES**
 - PLUG (STYLE M) HAS MARKINGS ON CHAMFER SIDE
 - RECEPTACLE (STYLE P) HAS MARKINGS ON RADIUS SIDE
 - FOR REVERSE SEE ORDERING CHART

**REFER TO APPENDIX FOR TERMINATION DETAILS,
 HARDWARE STYLES, AND PWB PATTERNS**

No. of Contacts	A	B	C	D
208	6.040 [153.42]	5.700 [144.78]	2.500 [63.50]	2.850 [72.39]
240	6.840 [173.74]	6.500 [165.10]	2.900 [73.66]	3.250 [82.55]
264	7.438 [188.92]	7.100 [180.34]	3.200 [81.28]	3.550 [90.17]
352	9.640 [244.86]	9.300 [236.22]	4.300 [109.22]	4.650 [118.11]
392	10.640 [270.26]	10.300 [261.62]	4.800 [121.92]	5.150 [130.81]

**PIN COMPLIANT
STYLE MV
*STYLE PV**

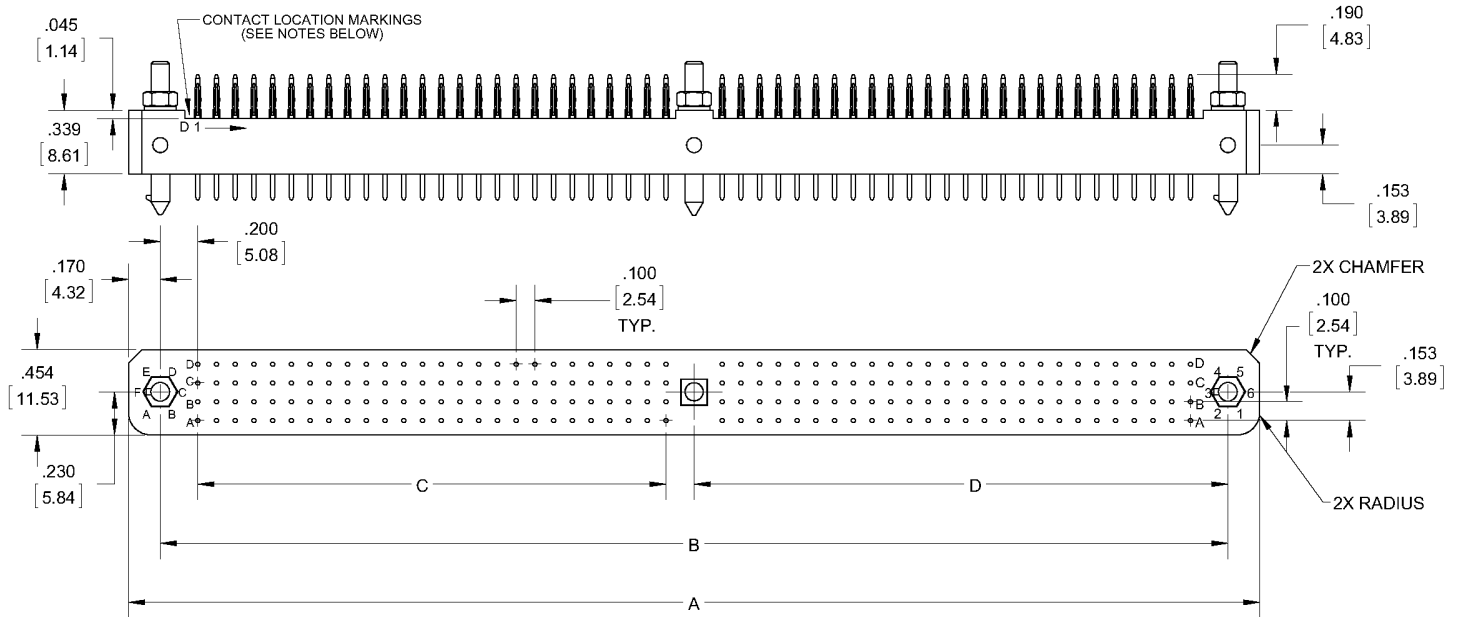

***CONTACT LOCATION MARKING NOTES**

- PLUG (STYLE M) HAS MARKINGS ON CHAMFER SIDE
- RECEPTACLE (STYLE P) HAS MARKINGS ON RADIUS SIDE
- FOR REVERSE SEE ORDERING CHART

REFER TO APPENDIX FOR TERMINATION DETAILS,
HARDWARE STYLES, AND PWB PATTERNS

No. of Contacts	A	B	C	D
208	6.040 [153.42]	5.700 [144.78]	2.500 [63.50]	2.850 [72.39]
240	6.840 [173.74]	6.500 [165.10]	2.900 [73.66]	3.250 [82.55]
264	7.438 [188.92]	7.100 [180.34]	3.200 [81.28]	3.550 [90.17]
352	9.640 [244.86]	9.300 [236.22]	4.300 [109.22]	4.650 [118.11]
392	10.640 [270.26]	10.300 [261.62]	4.800 [121.92]	5.150 [130.81]

SOCKET, STRAIGHT
STYLE FC, FD, FS, FW
***STYLE SC, SD, SS, SW**

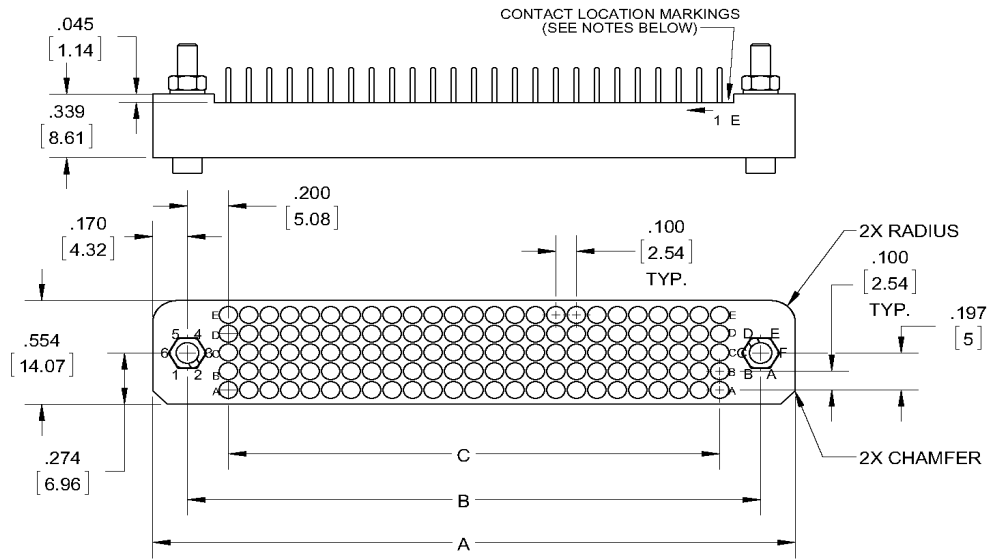

***CONTACT LOCATION MARKING NOTES**
 - PLUG (STYLE S) HAS MARKINGS ON CHAMFER SIDE
 - RECEPTACLE (STYLE F) HAS MARKINGS ON RADIUS SIDE
 - FOR REVERSE SEE ORDERING CHART

**REFER TO APPENDIX FOR TERMINATION DETAILS,
 HARDWARE STYLES, AND PWB PATTERNS**

No. of Contacts	A	B	C
125	3.140 [79.76]	2.800 [71.12]	2.400 [60.96]
140	3.440 [87.38]	3.100 [78.74]	2.700 [68.58]
160	3.840 [97.54]	3.500 [88.90]	3.100 [78.74]
200	4.640 [117.86]	4.300 [109.22]	3.900 [99.06]
230	5.240 [133.10]	4.900 [124.46]	4.500 [114.30]
240	5.440 [138.18]	5.100 [129.54]	4.700 [119.38]

SOCKET, RIGHT ANGLE
STYLE FE
***STYLE SE**

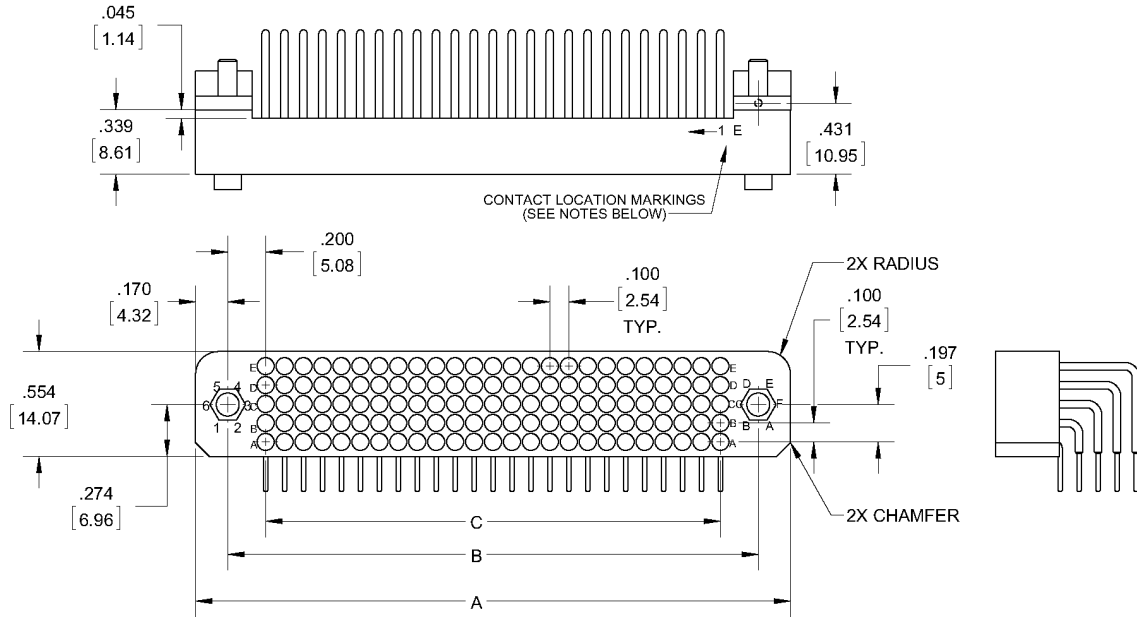

***CONTACT LOCATION MARKING NOTES**
 - PLUG (STYLE S) HAS MARKINGS ON CHAMFER SIDE
 - RECEPTACLE (STYLE F) HAS MARKINGS ON RADIUS SIDE
 - FOR REVERSE SEE ORDERING CHART

**REFER TO APPENDIX FOR TERMINATION DETAILS,
 HARDWARE STYLES, AND PWB PATTERNS**

No. of Contacts	A	B	C
125	3.140 [79.76]	2.800 [71.12]	2.400 [60.96]
140	3.440 [87.38]	3.100 [78.74]	2.700 [68.58]
160	3.840 [97.54]	3.500 [88.90]	3.100 [78.74]
200	4.640 [117.86]	4.300 [109.22]	3.900 [99.06]
230	5.240 [133.10]	4.900 [124.46]	4.500 [114.30]
240	5.440 [138.18]	5.100 [129.54]	4.700 [119.38]

**SOCKET, COMPLIANT
STYLE FV
*STYLE SV**

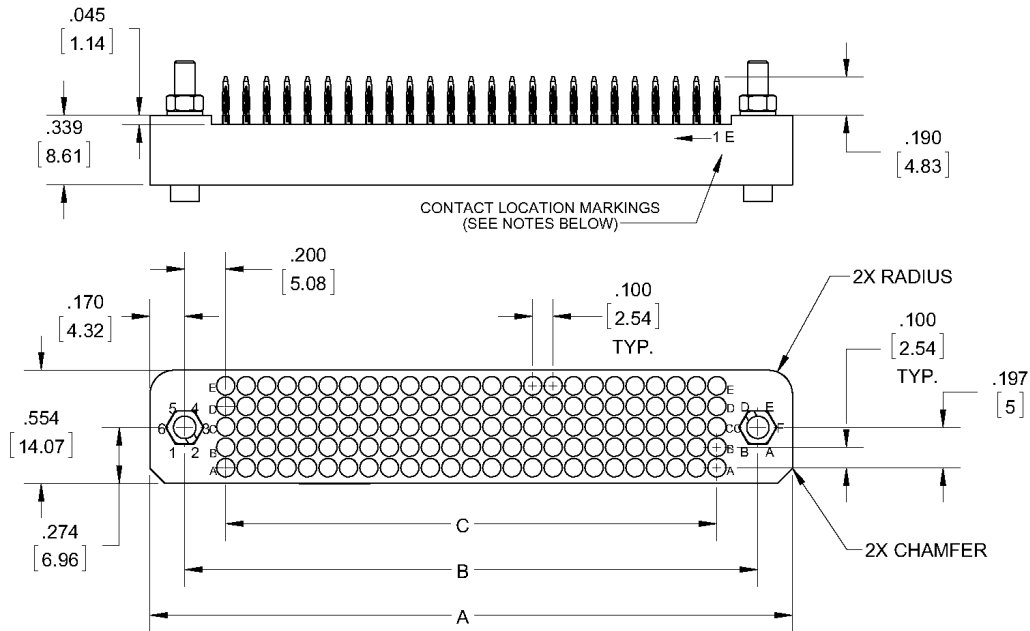

***CONTACT LOCATION MARKING NOTES**

- PLUG (STYLE S) HAS MARKINGS ON CHAMFER SIDE
- RECEPTACLE (STYLE F) HAS MARKINGS ON RADIUS SIDE
- FOR REVERSE SEE ORDERING CHART

REFER TO APPENDIX FOR TERMINATION DETAILS,
HARDWARE STYLES, AND PWB PATTERNS

No. of Contacts	A	B	C
125	3.140 [79.76]	2.800 [71.12]	2.400 [60.96]
140	3.440 [87.38]	3.100 [78.74]	2.700 [68.58]
160	3.840 [97.54]	3.500 [88.90]	3.100 [78.74]
200	4.640 [117.86]	4.300 [109.22]	3.900 [99.06]
230	5.240 [133.10]	4.900 [124.46]	4.500 [114.30]
240	5.440 [138.18]	5.100 [129.54]	4.700 [119.38]

PIN, STRAIGHT STYLE MC, MD, MS, MW *STYLE PC, PD, PS, PW

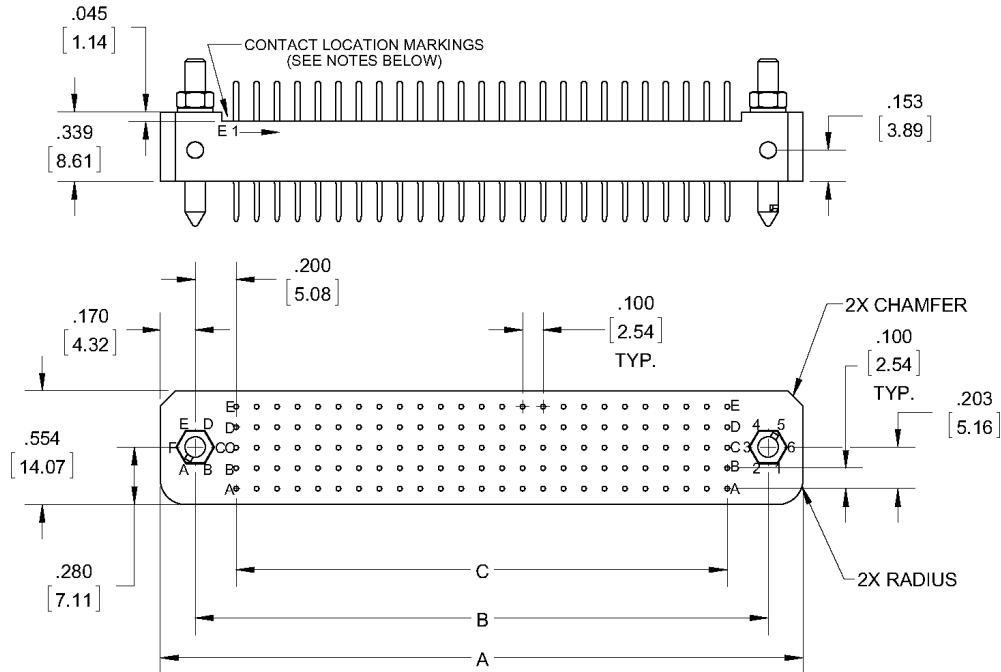

*CONTACT LOCATION MARKING NOTES

- PLUG (STYLE M) HAS MARKINGS ON CHAMFER SIDE
- RECEPTACLE (STYLE P) HAS MARKINGS ON RADIUS SIDE
- FOR REVERSE SEE ORDERING CHART

REFER TO APPENDIX FOR TERMINATION DETAILS,
HARDWARE STYLES, AND PWB PATTERNS

No. of Contacts	A	B	C
125	3.140 [79.76]	2.800 [71.12]	2.400 [60.96]
140	3.440 [87.38]	3.100 [78.74]	2.700 [68.58]
160	3.840 [97.54]	3.500 [88.90]	3.100 [78.74]
200	4.640 [117.86]	4.300 [109.22]	3.900 [99.06]
230	5.240 [133.10]	4.900 [124.46]	4.500 [114.30]
240	5.440 [138.18]	5.100 [129.54]	4.700 [119.38]

**PIN, RIGHT ANGLE
STYLE ME
*STYLE PE**

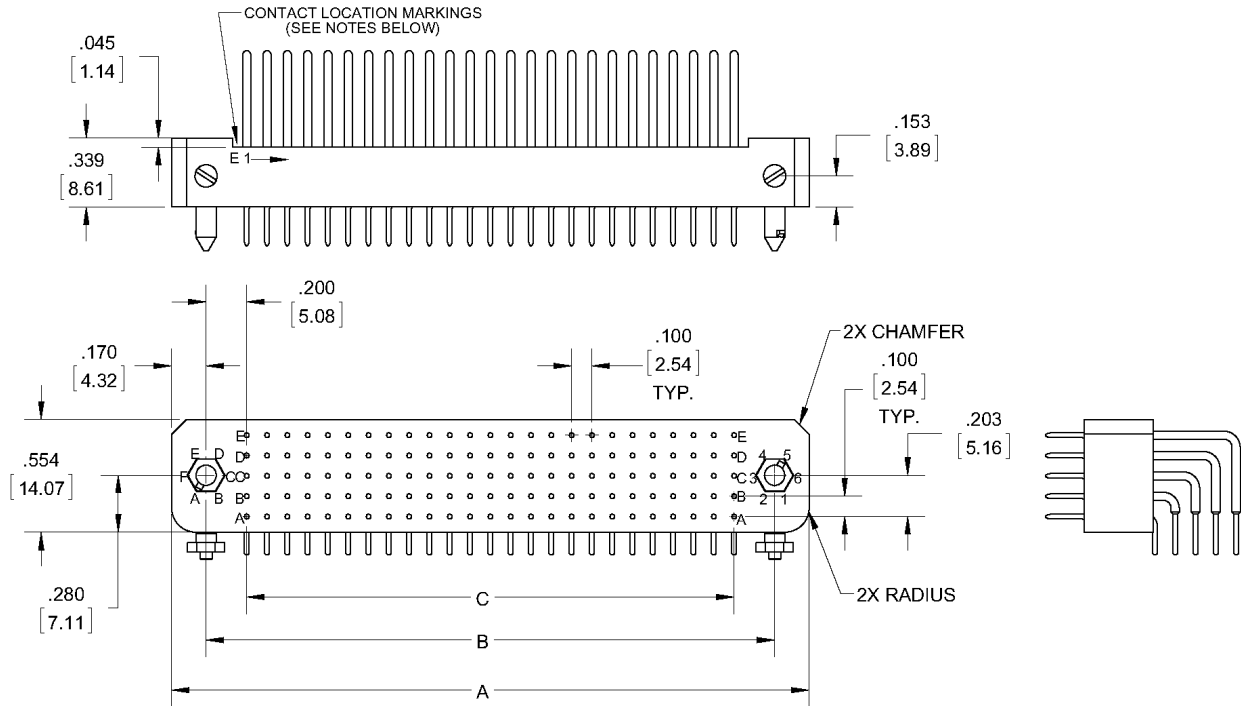

***CONTACT LOCATION MARKING NOTES**
 - PLUG (STYLE M) HAS MARKINGS ON CHAMFER SIDE
 - RECEPTACLE (STYLE P) HAS MARKINGS ON RADIUS SIDE
 - FOR REVERSE SEE ORDERING CHART

REFER TO APPENDIX FOR TERMINATION DETAILS,
 HARDWARE STYLES, AND PWB PATTERNS

No. of Contacts	A	B	C
125	3.140 [79.76]	2.800 [71.12]	2.400 [60.96]
140	3.440 [87.38]	3.100 [78.74]	2.700 [68.58]
160	3.840 [97.54]	3.500 [88.90]	3.100 [78.74]
200	4.640 [117.86]	4.300 [109.22]	3.900 [99.06]
230	5.240 [133.10]	4.900 [124.46]	4.500 [114.30]
240	5.440 [138.18]	5.100 [129.54]	4.700 [119.38]

**PIN, COMPLIANT
STYLE MV
*STYLE PV**

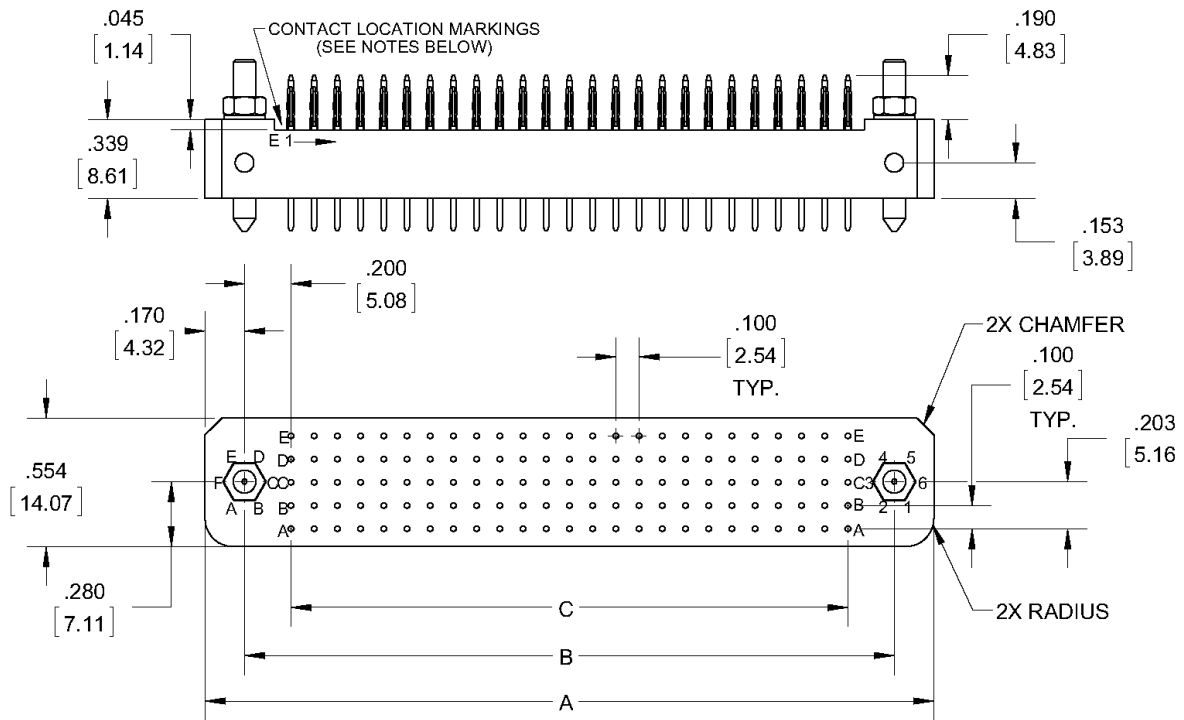

***CONTACT LOCATION MARKING NOTES**
 - PLUG (STYLE M) HAS MARKINGS ON CHAMFER SIDE
 - RECEPTACLE (STYLE P) HAS MARKINGS ON RADIUS SIDE
 - FOR REVERSE SEE ORDERING CHART

REFER TO APPENDIX FOR TERMINATION DETAILS,
 HARDWARE STYLES, AND PWB PATTERNS

No. of Contacts	A	B	C
125	3.140 [79.76]	2.800 [71.12]	2.400 [60.96]
140	3.440 [87.38]	3.100 [78.74]	2.700 [68.58]
160	3.840 [97.54]	3.500 [88.90]	3.100 [78.74]
200	4.640 [117.86]	4.300 [109.22]	3.900 [99.06]
230	5.240 [133.10]	4.900 [124.46]	4.500 [114.30]
240	5.440 [138.18]	5.100 [129.54]	4.700 [119.38]

SOCKET, STRAIGHT
STYLE FC, FD, FS, FW
***STYLE SC, SD, SS, SW**

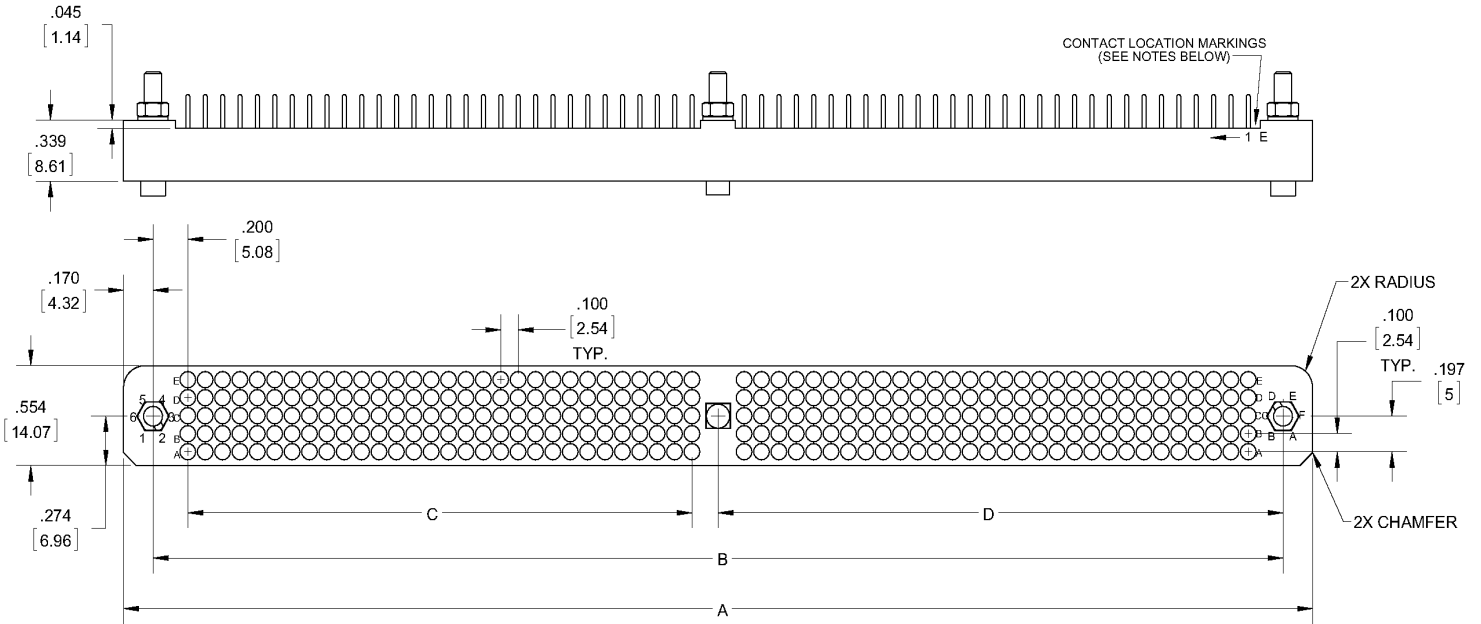

***CONTACT LOCATION MARKING NOTES**

- PLUG (STYLE S) HAS MARKINGS ON CHAMFER SIDE
- RECEPTACLE (STYLE F) HAS MARKINGS ON RADIUS SIDE
- FOR REVERSE SEE ORDERING CHART

**REFER TO APPENDIX FOR TERMINATION DETAILS,
 HARDWARE STYLES, AND PWB PATTERNS**

No. of Contacts	A	B	C	D
300	6.840 [173.74]	6.500 [165.1]	2.900 [73.66]	3.250 [82.55]
320	7.240 [183.90]	6.900 [175.26]	3.100 [78.74]	3.450 [87.63]
330	7.440 [188.98]	7.100 [180.34]	3.200 [81.28]	3.550 [90.17]
390	8.640 [219.46]	8.300 [210.82]	3.800 [96.52]	4.150 [105.41]
490	10.640 [270.26]	10.300 [261.62]	4.800 [121.92]	5.150 [130.81]

**SOCKET, RIGHT ANGLE
STYLE FE
*STYLE SE**

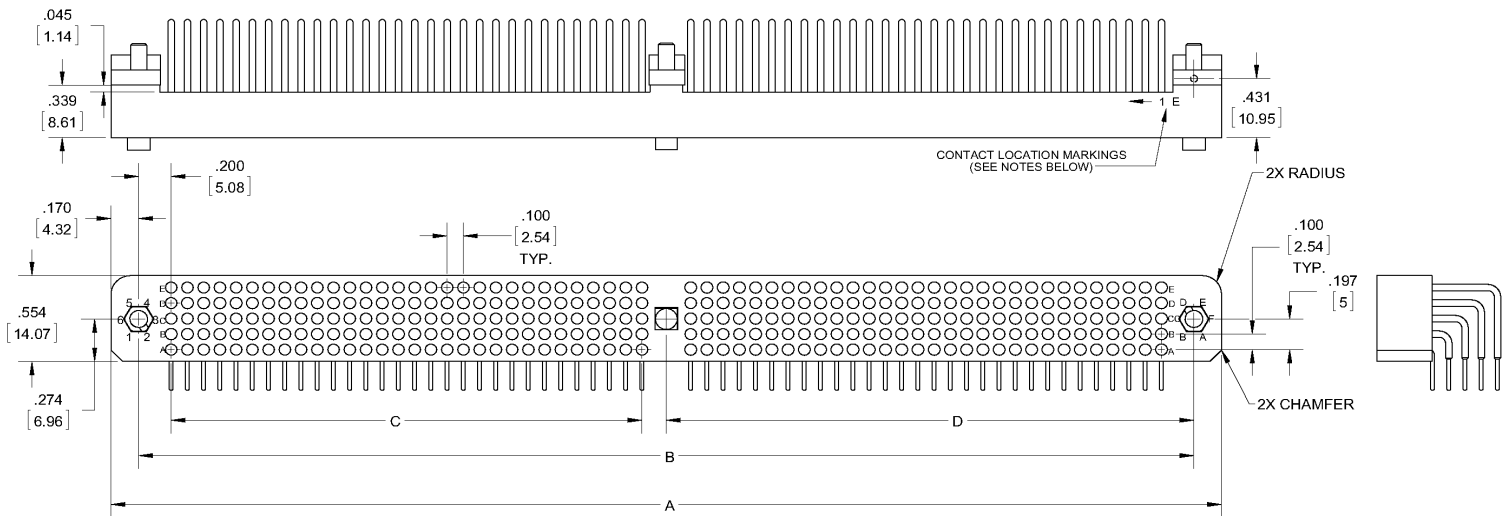

***CONTACT LOCATION MARKING NOTES**

- PLUG (STYLE S) HAS MARKINGS ON CHAMFER SIDE
- RECEPTACLE (STYLE F) HAS MARKINGS ON RADIUS SIDE
- FOR REVERSE SEE ORDERING CHART

REFER TO APPENDIX FOR TERMINATION DETAILS,
HARDWARE STYLES, AND PWB PATTERNS

No. of Contacts	A	B	C	D
300	6.840 [173.74]	6.500 [165.1]	2.900 [73.66]	3.250 [82.55]
320	7.240 [183.90]	6.900 [175.26]	3.100 [78.74]	3.450 [87.63]
330	7.440 [188.98]	7.100 [180.34]	3.200 [81.28]	3.550 [90.17]
390	8.640 [219.46]	8.300 [210.82]	3.800 [96.52]	4.150 [105.41]
490	10.640 [270.26]	10.300 [261.62]	4.800 [121.92]	5.150 [130.81]

**SOCKET, COMPLIANT
STYLE FV
*STYLE SV**

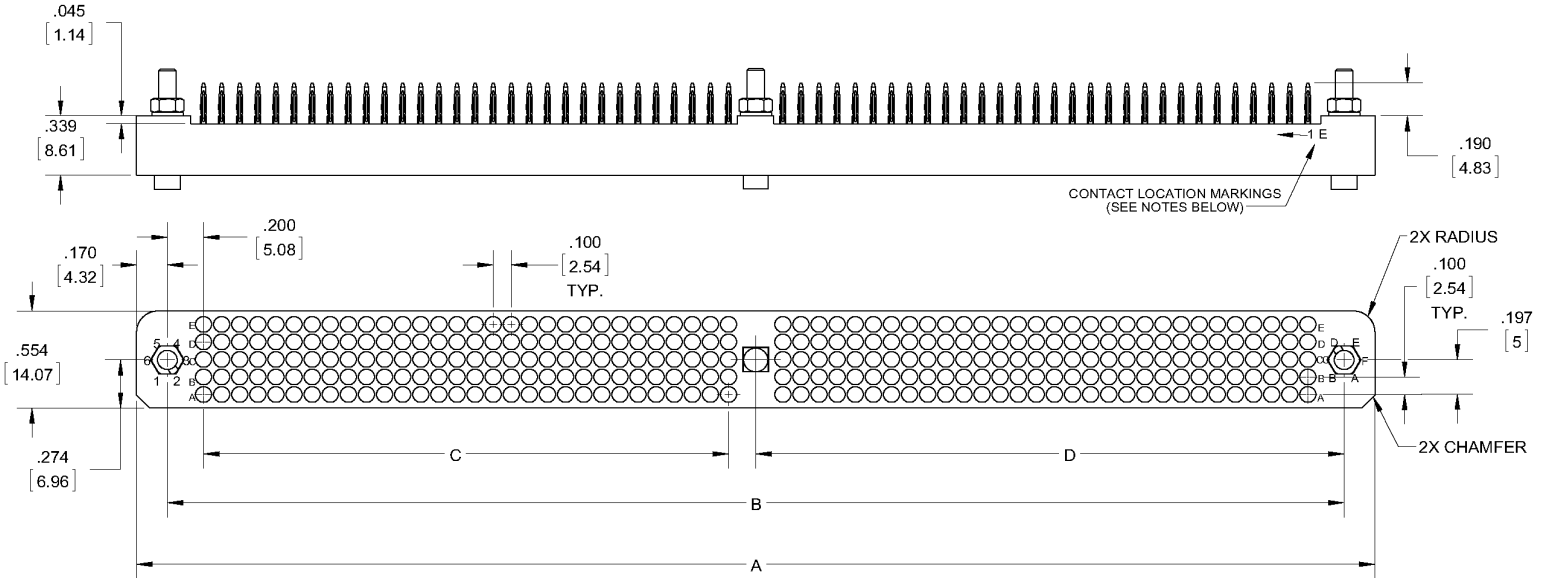

***CONTACT LOCATION MARKING NOTES**

- PLUG (STYLE S) HAS MARKINGS ON CHAMFER SIDE
- RECEPTACLE (STYLE F) HAS MARKINGS ON RADIUS SIDE
- FOR REVERSE SEE ORDERING CHART

**REFER TO APPENDIX FOR TERMINATION DETAILS,
HARDWARE STYLES, AND PWB PATTERNS**

No. of Contacts	A	B	C	D
300	6.840 [173.74]	6.500 [165.1]	2.900 [73.66]	3.250 [82.55]
320	7.240 [183.90]	6.900 [175.26]	3.100 [78.74]	3.450 [87.63]
330	7.440 [188.98]	7.100 [180.34]	3.200 [81.28]	3.550 [90.17]
390	8.640 [219.46]	8.300 [210.82]	3.800 [96.52]	4.150 [105.41]
490	10.640 [270.26]	10.300 [261.62]	4.800 [121.92]	5.150 [130.81]

PIN, STRAIGHT
STYLE MC, MD, MS, MW
***STYLE PC, PD, PS, PW**

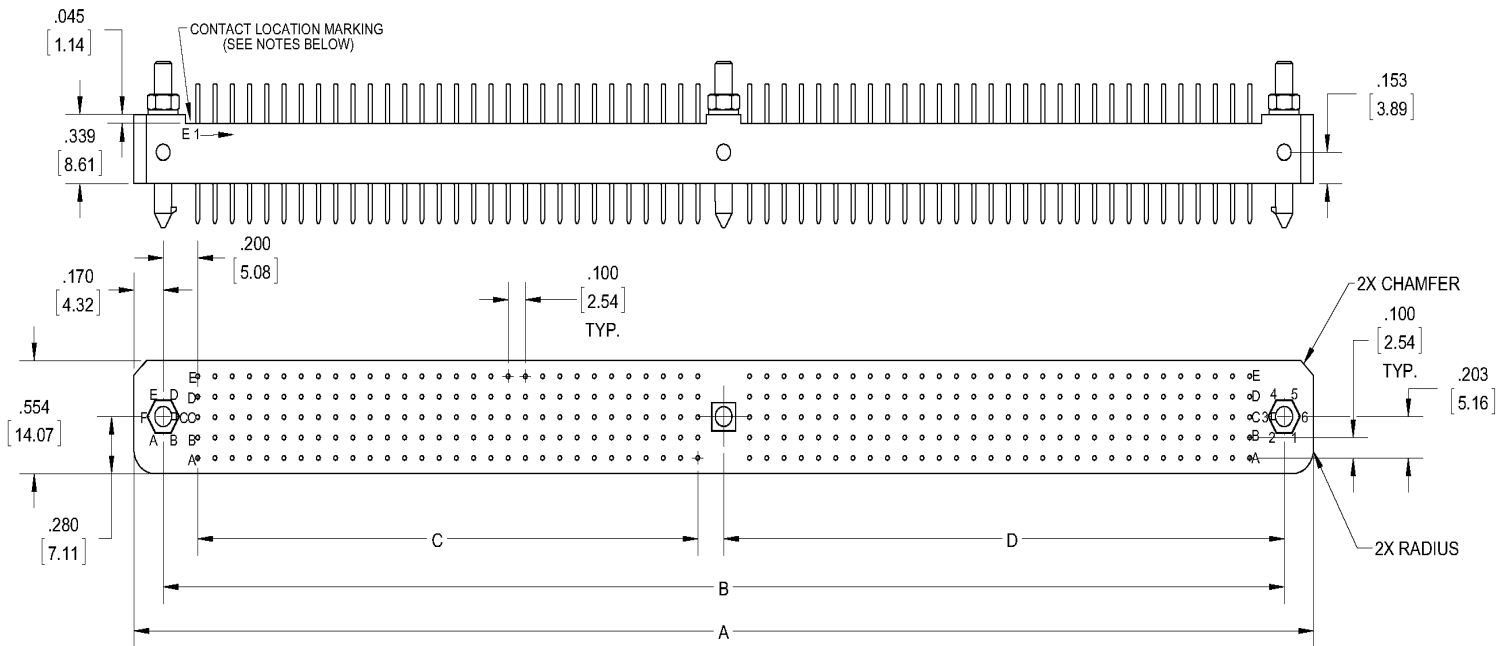

***CONTACT LOCATION MARKING NOTES**

- PLUG (STYLE M) HAS MARKINGS ON CHAMFER SIDE
- RECEPTACLE (STYLE P) HAS MARKINGS ON RADIUS SIDE
- FOR REVERSE SEE ORDERING CHART

REFER TO APPENDIX FOR TERMINATION DETAILS,
 HARDWARE STYLES, AND PWB PATTERNS

No. of Contacts	A	B	C	D
300	6.840 [173.74]	6.500 [165.1]	2.900 [73.66]	3.250 [82.55]
320	7.240 [183.90]	6.900 [175.26]	3.100 [78.74]	3.450 [87.63]
330	7.440 [188.98]	7.100 [180.34]	3.200 [81.28]	3.550 [90.17]
390	8.640 [219.46]	8.300 [210.82]	3.800 [96.52]	4.150 [105.41]
490	10.640 [270.26]	10.300 [261.62]	4.800 [121.92]	5.150 [130.81]

**PIN, RIGHT ANGLE
STYLE ME
*STYLE PE**

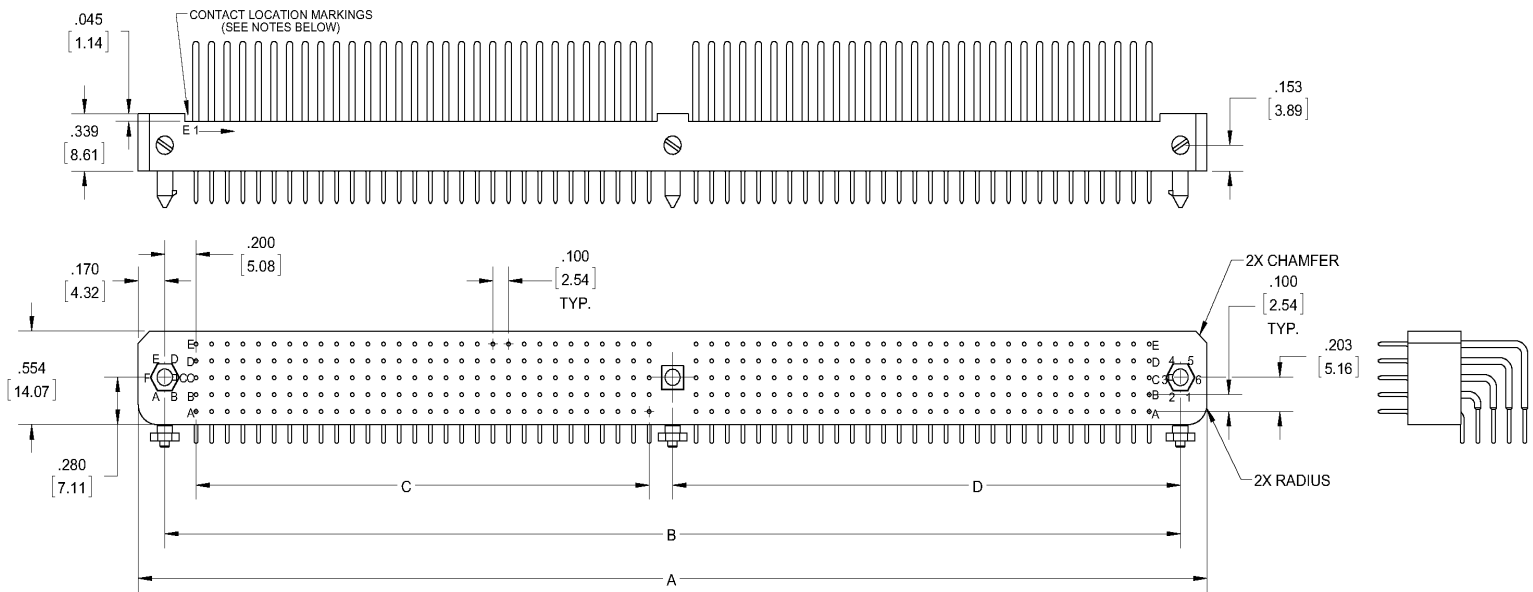

***CONTACT LOCATION MARKING NOTES**

- PLUG (STYLE M) HAS MARKINGS ON CHAMFER SIDE
- RECEPTACLE (STYLE P) HAS MARKINGS ON RADIUS SIDE
- FOR REVERSE SEE ORDERING CHART

REFER TO APPENDIX FOR TERMINATION DETAILS,
HARDWARE STYLES, AND PWB PATTERNS

No. of Contacts	A	B	C	D
300	6.840 [173.74]	6.500 [165.1]	2.900 [73.66]	3.250 [82.55]
320	7.240 [183.90]	6.900 [175.26]	3.100 [78.74]	3.450 [87.63]
330	7.440 [188.98]	7.100 [180.34]	3.200 [81.28]	3.550 [90.17]
390	8.640 [219.46]	8.300 [210.82]	3.800 [96.52]	4.150 [105.41]
490	10.640 [270.26]	10.300 [261.62]	4.800 [121.92]	5.150 [130.81]

**PIN, COMPLIANT
STYLE MV
*STYLE PV**

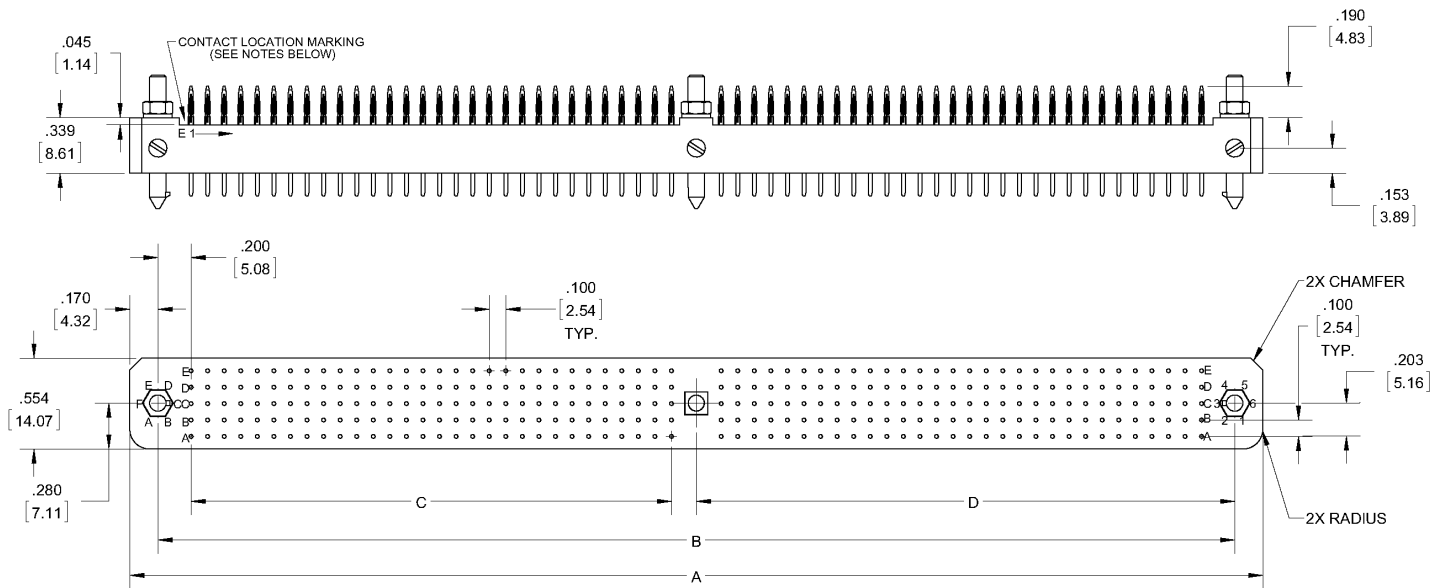

***CONTACT LOCATION MARKING NOTES**

- PLUG (STYLE M) HAS MARKINGS ON CHAMFER SIDE
- RECEPTACLE (STYLE P) HAS MARKINGS ON RADIUS SIDE
- FOR REVERSE SEE ORDERING CHART

REFER TO APPENDIX FOR TERMINATION DETAILS,
HARDWARE STYLES, AND PWB PATTERNS

No. of Contacts	A	B	C	D
300	6.840 [173.74]	6.500 [165.1]	2.900 [73.66]	3.250 [82.55]
320	7.240 [183.90]	6.900 [175.26]	3.100 [78.74]	3.450 [87.63]
330	7.440 [188.98]	7.100 [180.34]	3.200 [81.28]	3.550 [90.17]
390	8.640 [219.46]	8.300 [210.82]	3.800 [96.52]	4.150 [105.41]
490	10.640 [270.26]	10.300 [261.62]	4.800 [121.92]	5.150 [130.81]

TERMINATION STYLES SOCKET, 2 ROW HARDWARE OMITTED FOR CLARITY

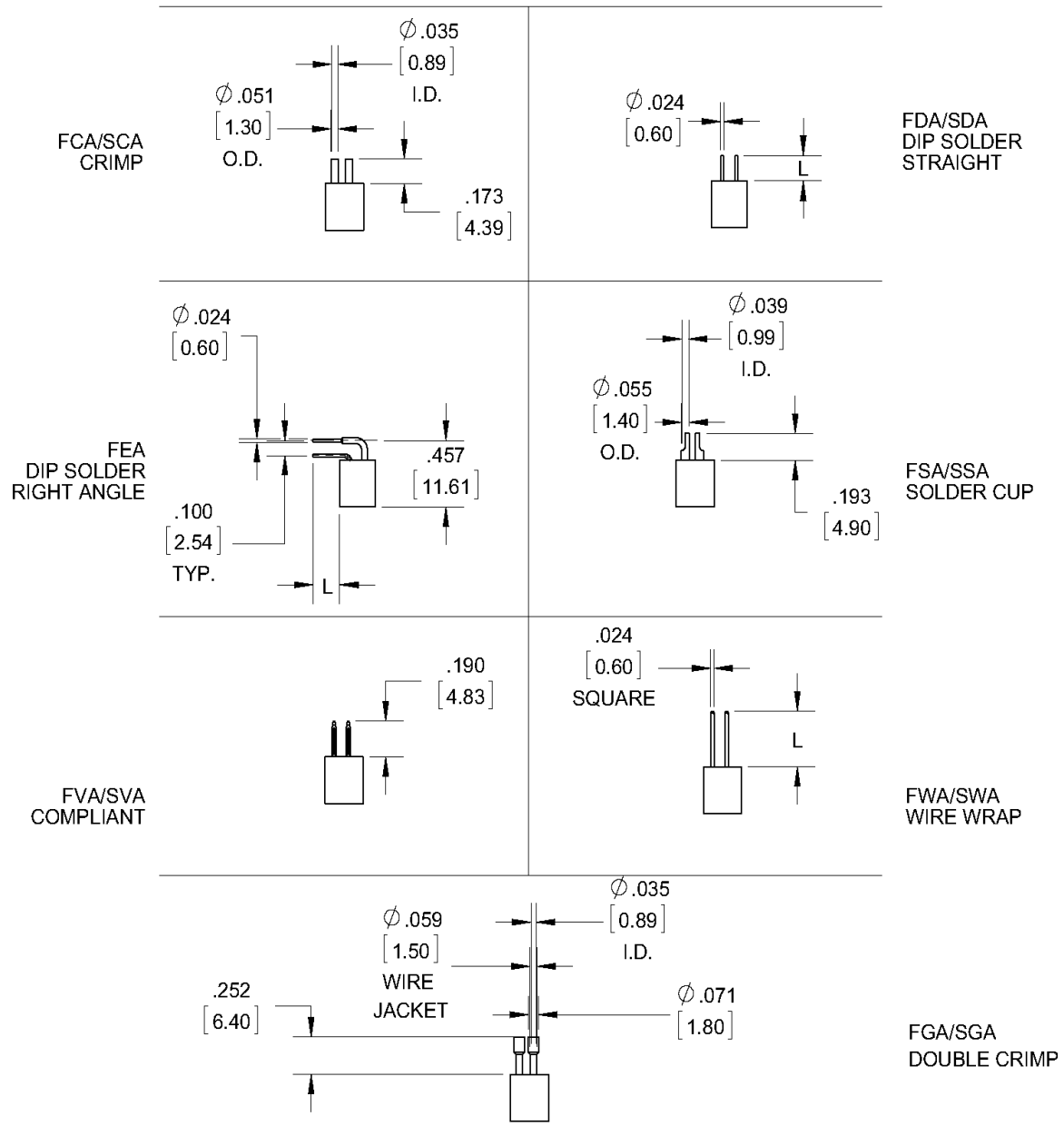

TERMINATION STYLES
PIN, 2 ROW
HARDWARE OMITTED FOR CLARITY
PIN SHIELDS OPTIONAL

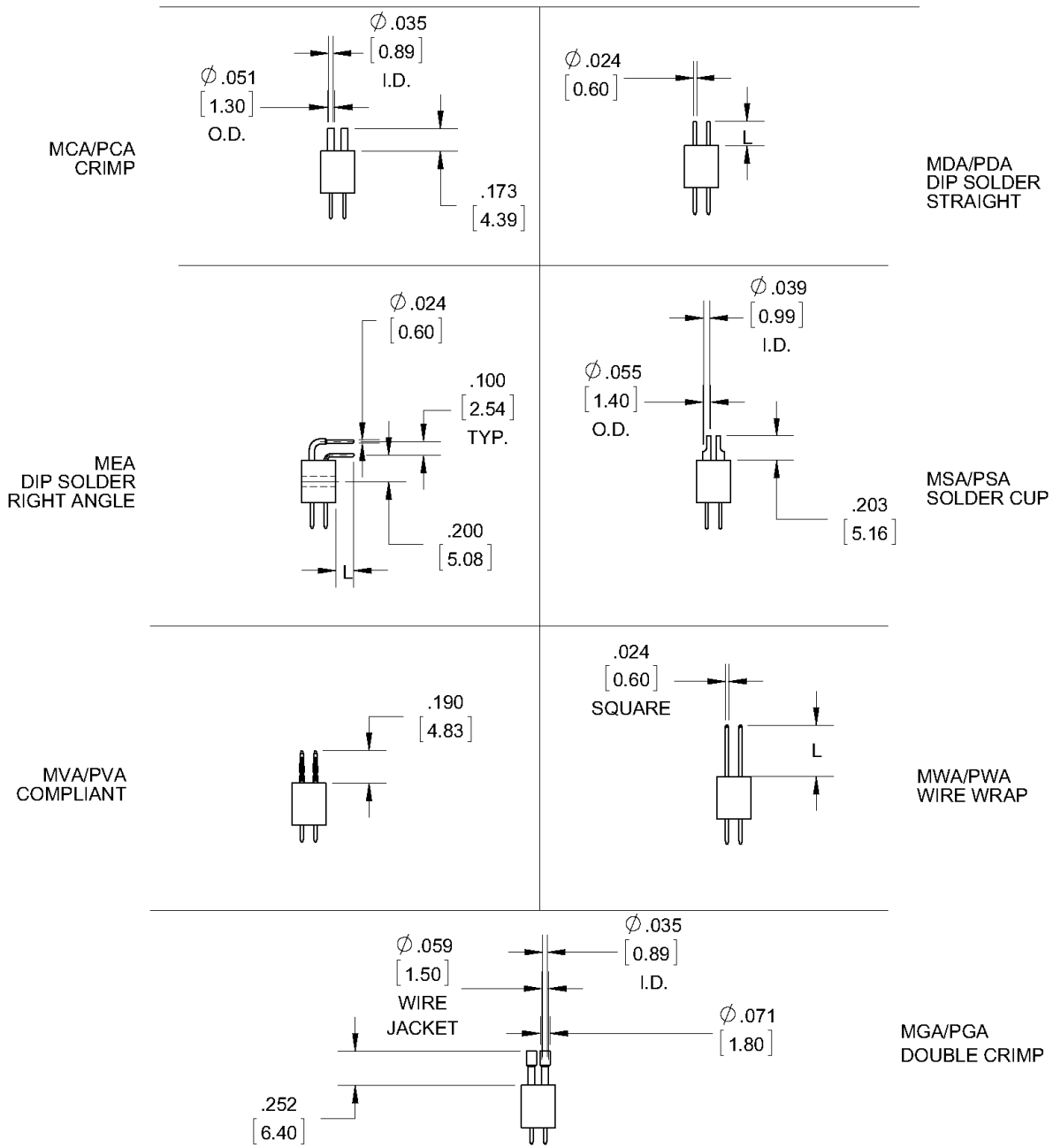

TERMINATION STYLES SOCKET, 3 ROW HARDWARE OMITTED FOR CLARITY

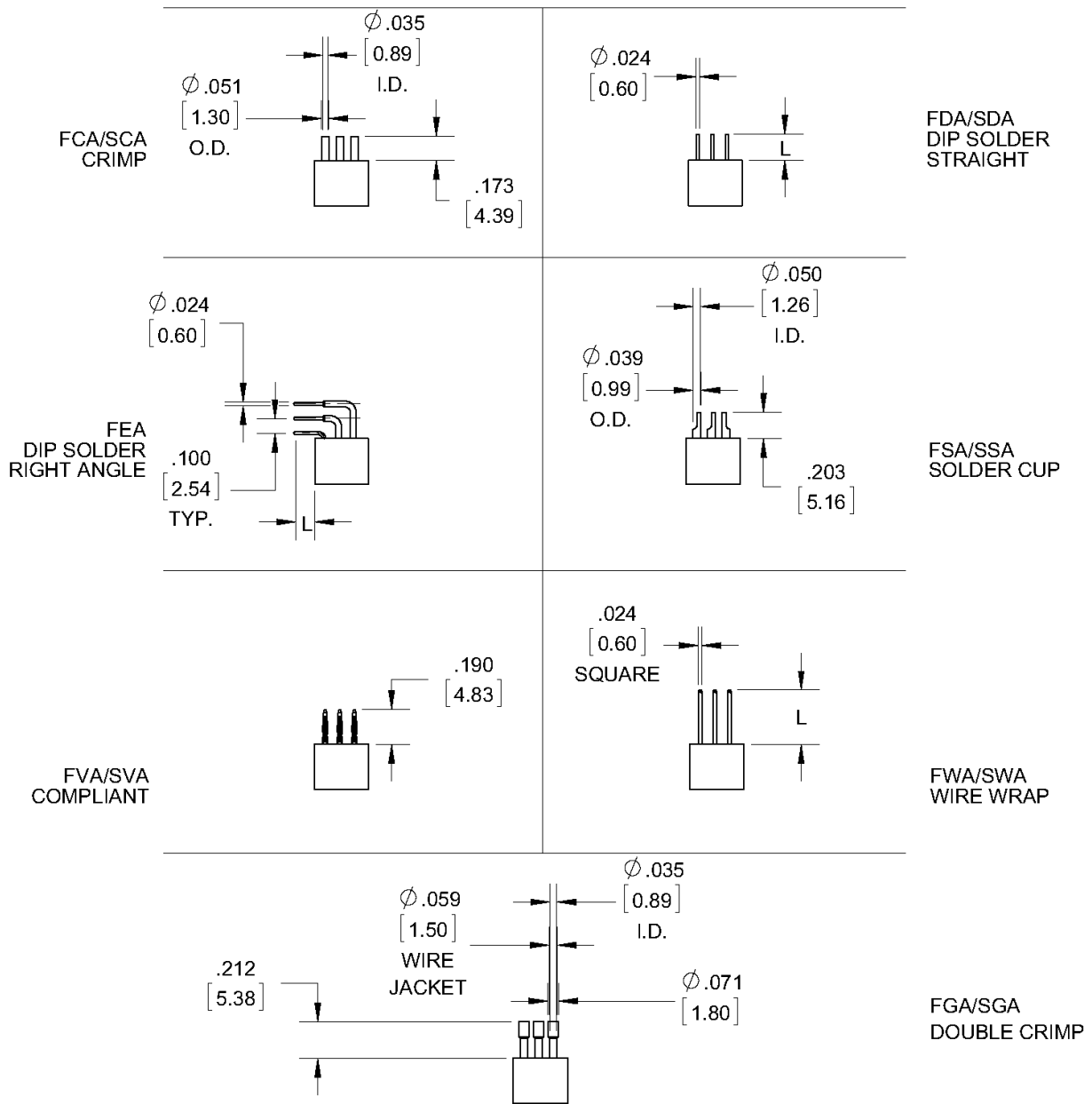

TERMINATION STYLES
PIN, 3 ROW
HARDWARE OMITTED FOR CLARITY
PIN SHIELDS OPTIONAL

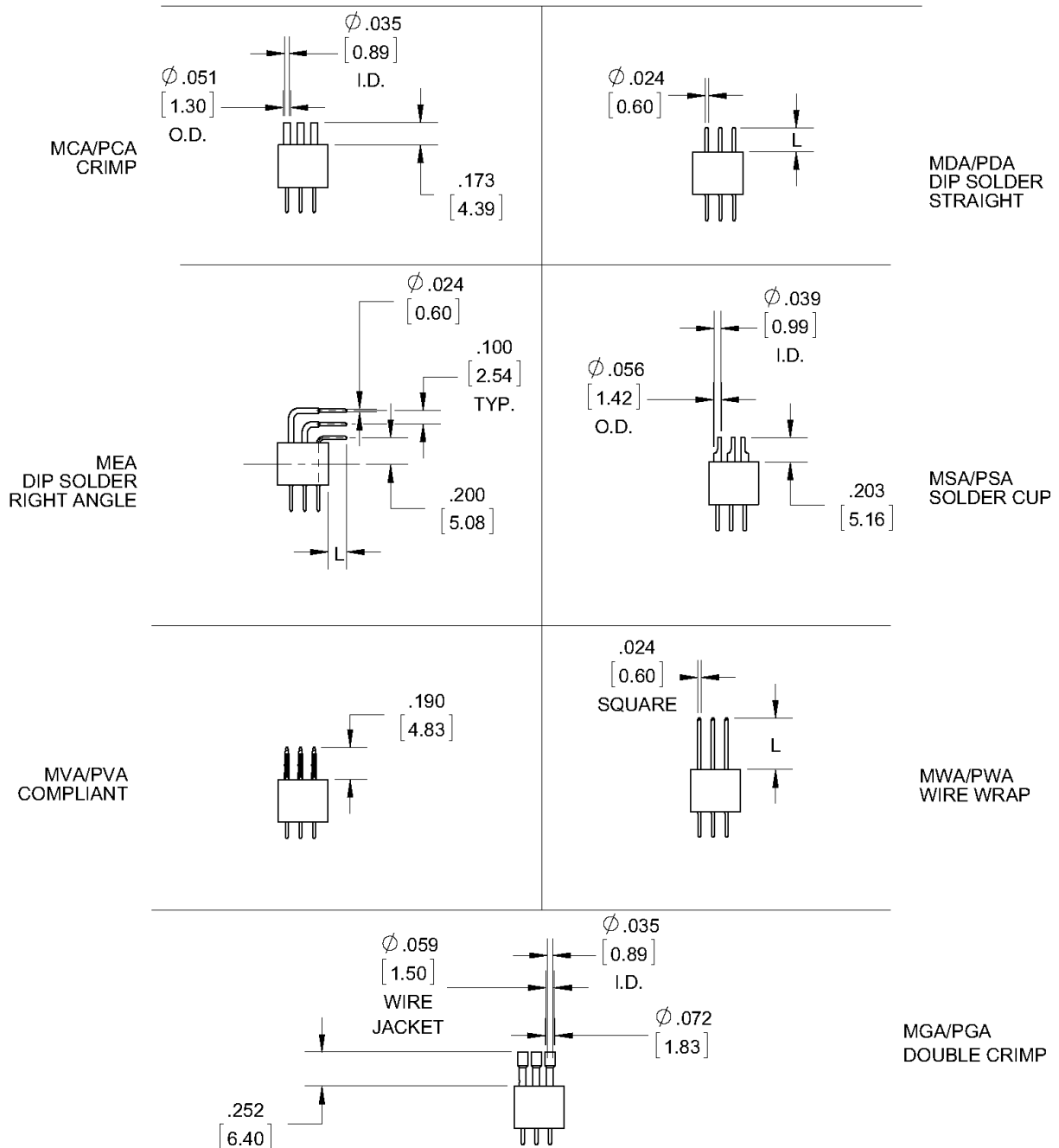

TERMINATION STYLES SOCKET, 4 ROW HARDWARE OMITTED FOR CLARITY

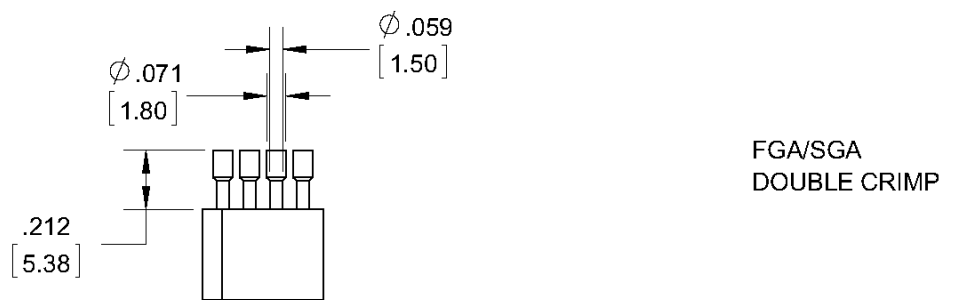
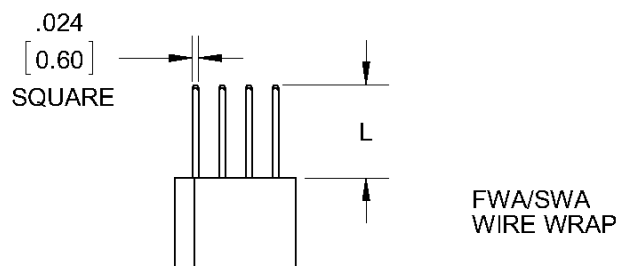
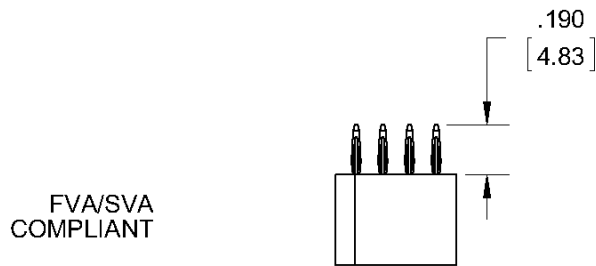
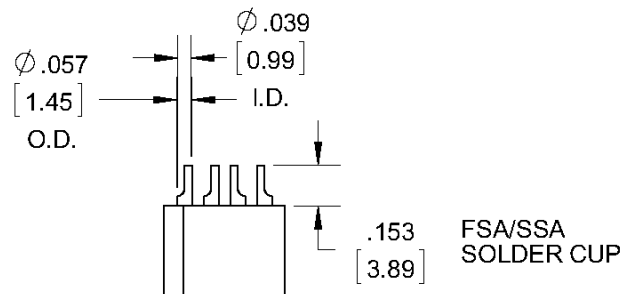
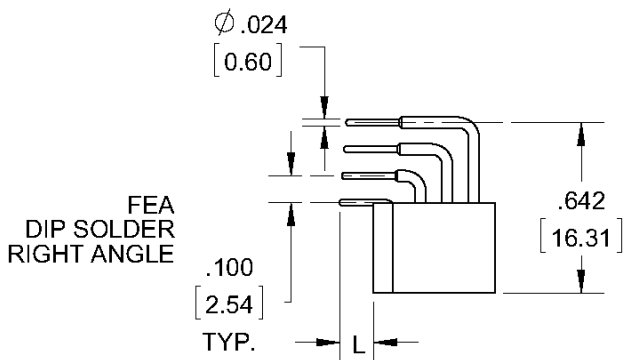
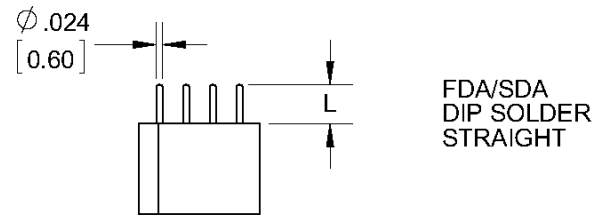
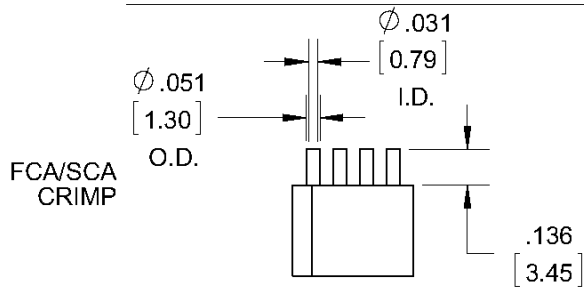

TERMINATION STYLES
PIN, 4 ROW
HARDWARE OMITTED FOR CLARITY
PIN SHIELDS OPTIONAL

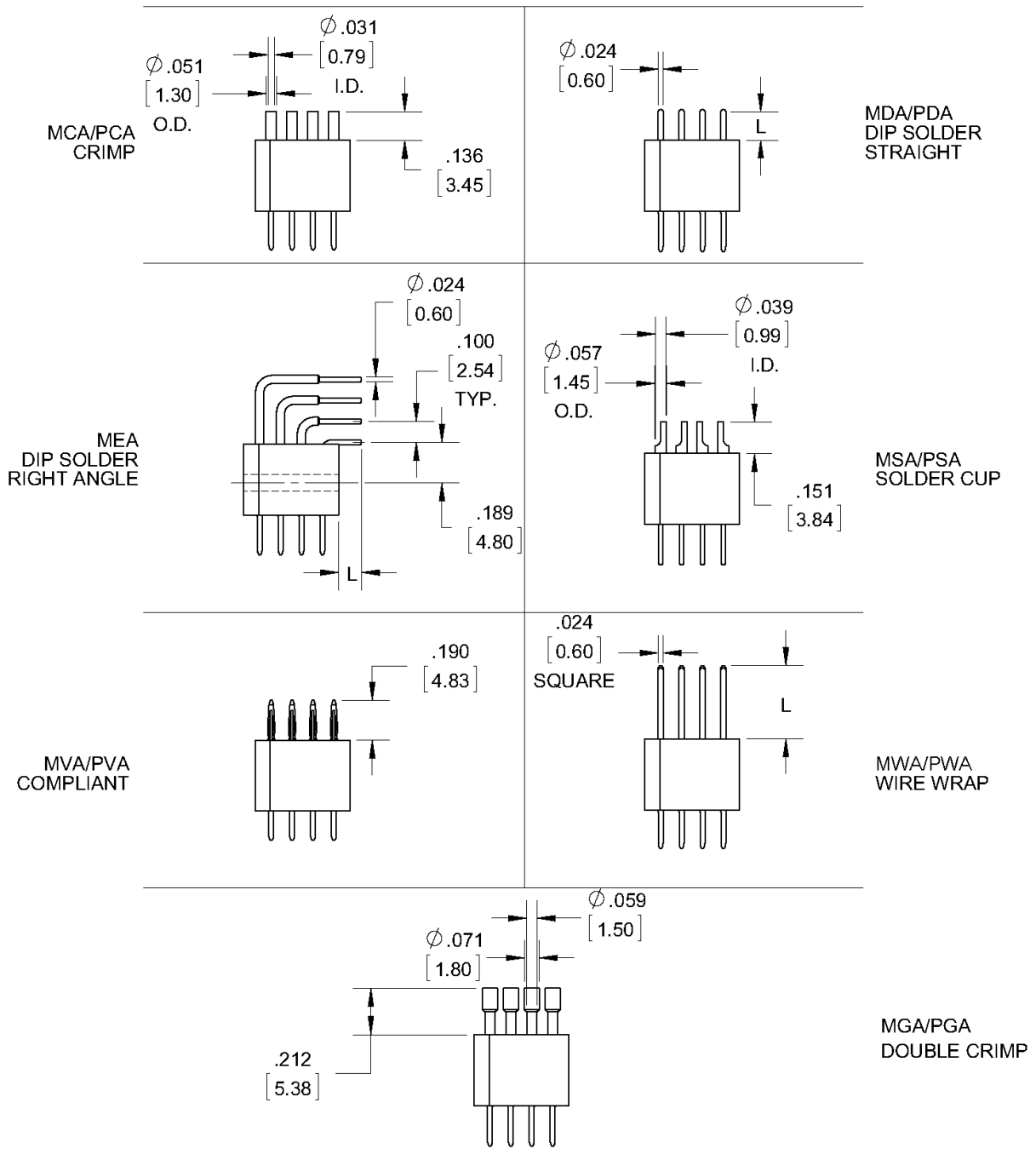

TERMINATION STYLES SOCKET, 5 ROW HARDWARE OMITTED FOR CLARITY

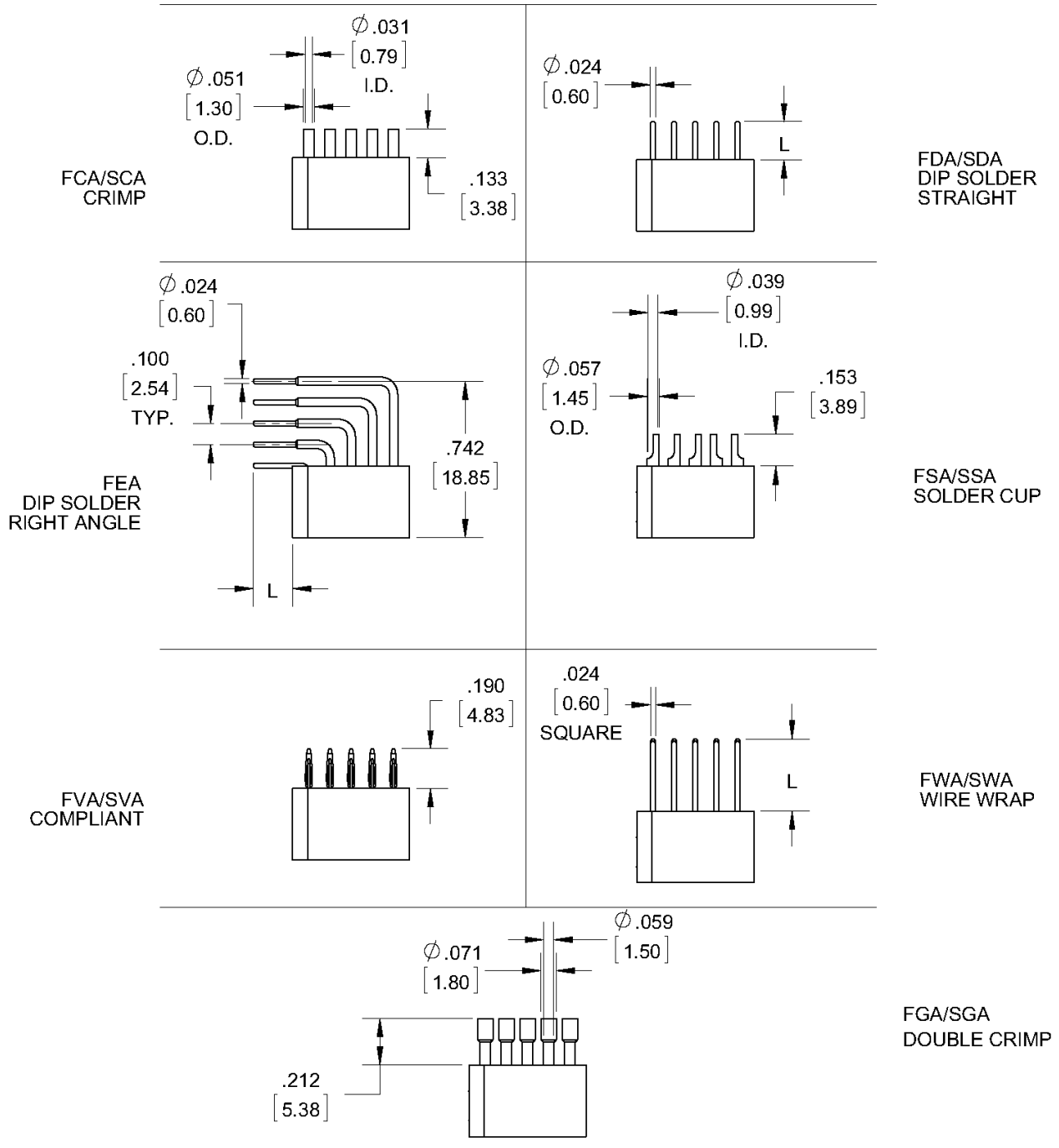

TERMINATION STYLES
PIN, 5 ROW
HARDWARE OMITTED FOR CLARITY
PIN SHIELDS OPTIONAL

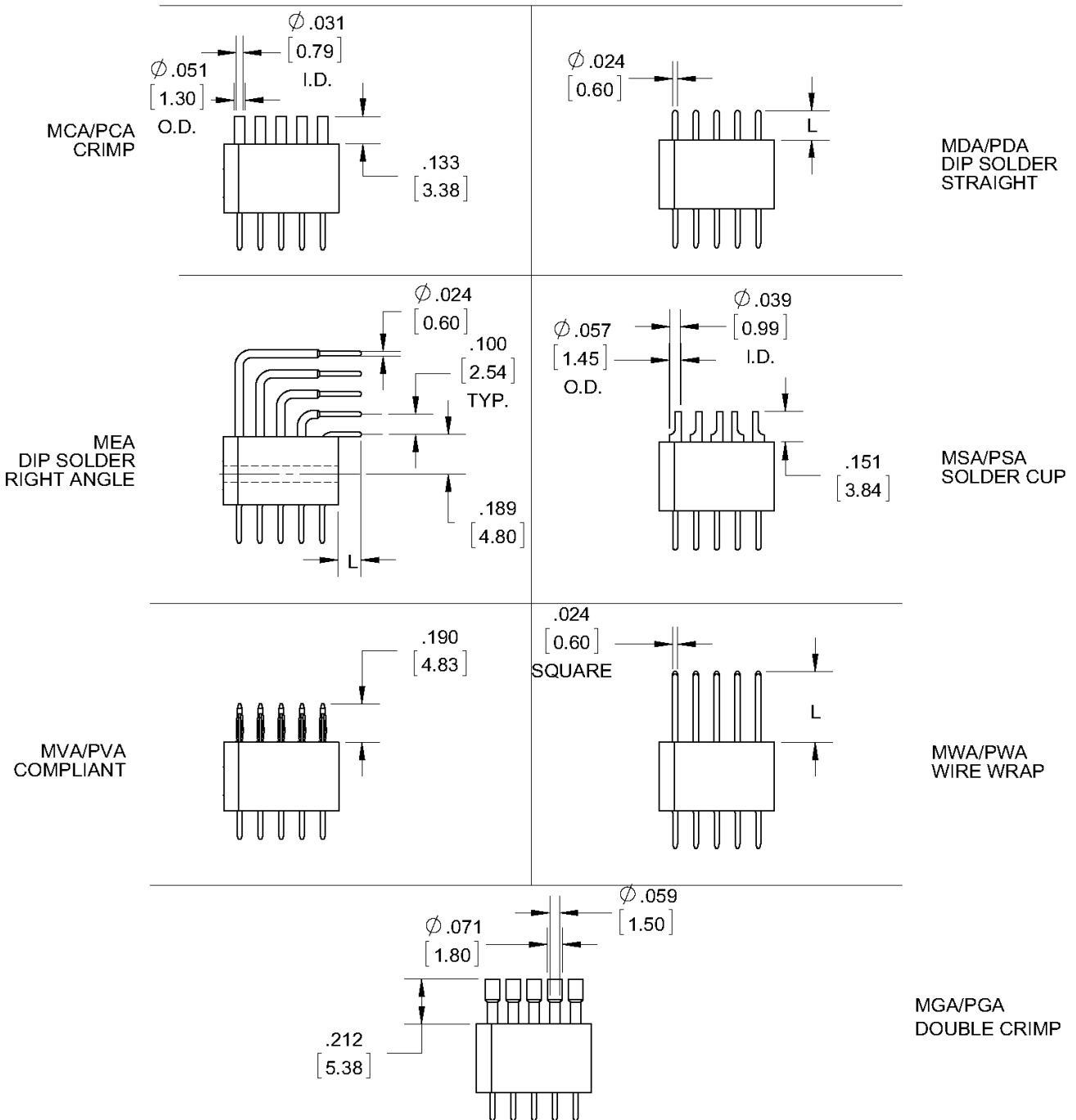

HARDWARE STYLES GUIDE SOCKETS, 2 & 3 ROW HARDWARE CONFIGURATION SHOWN ASSEMBLED

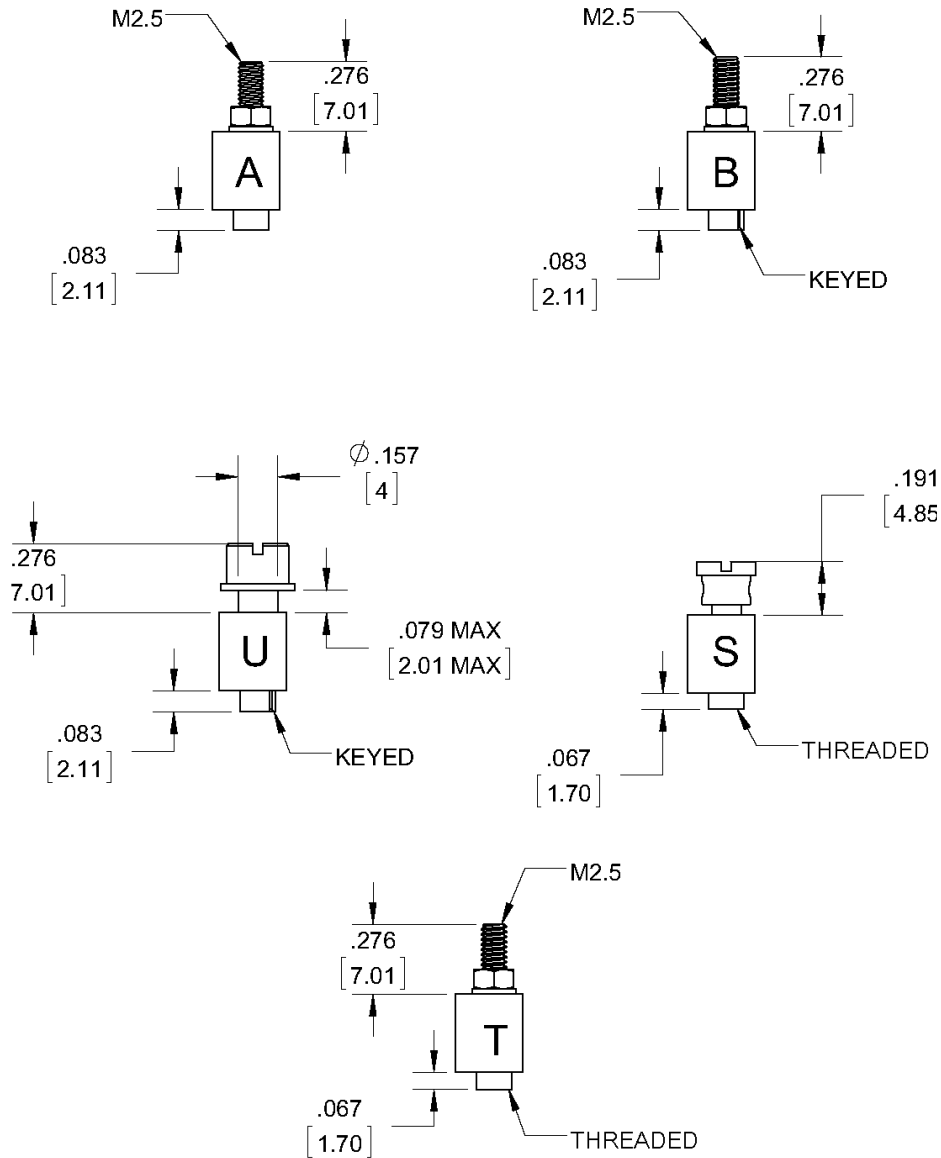

HARDWARE COMPATIBILITY									
GUIDE SOCKETS	GUIDE PINS								
	A	B	U	K	P	T	X	Y	
A	•						•		
B		•	•					•	
U		•	•					•	
S				•	•	•			
T					•				

**HARDWARE STYLES
GUIDE PINS, 2 & 3 ROW
HARDWARE CONFIGURATION SHOWN ASSEMBLED
PIN SHIELD OPTIONAL**

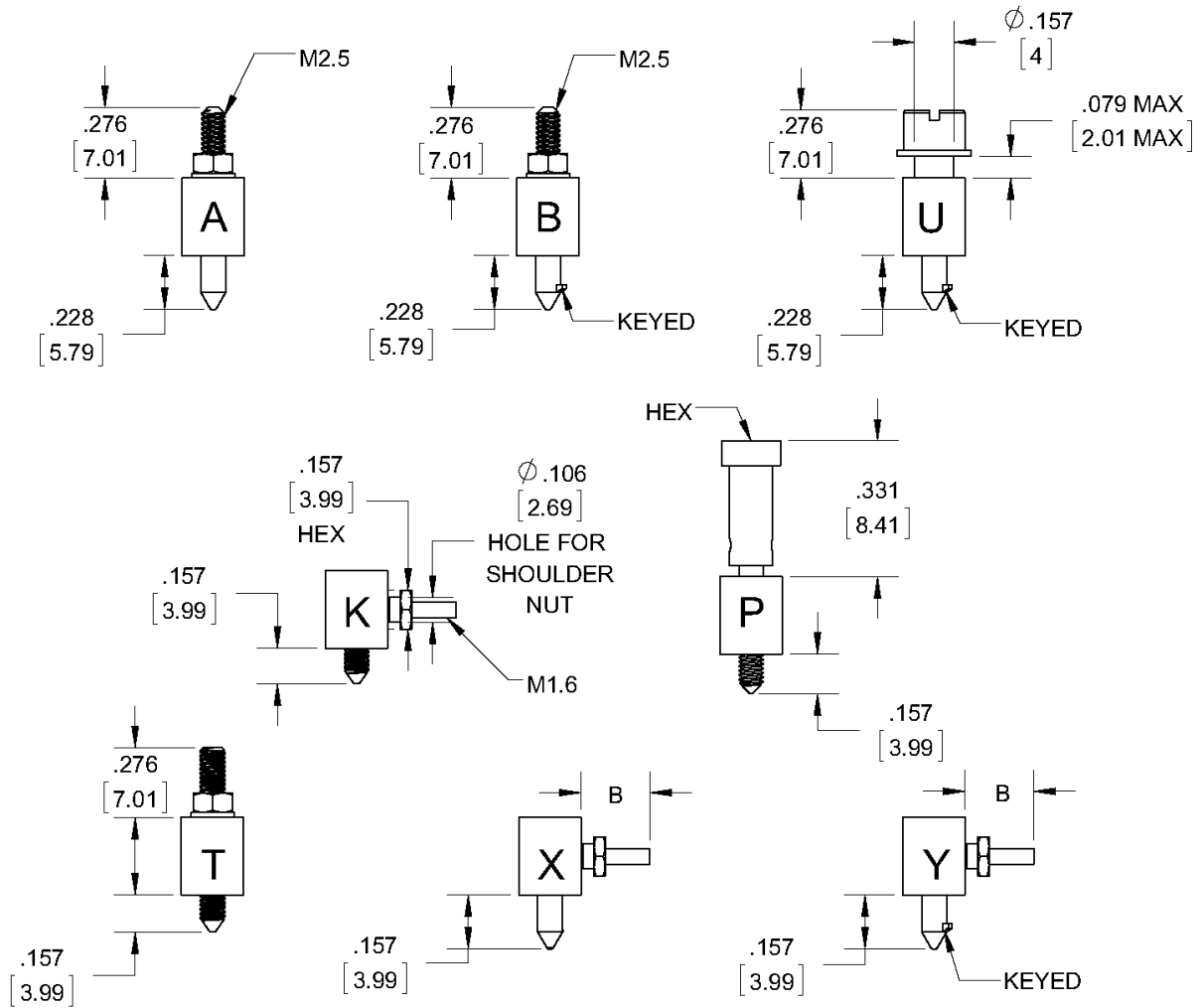

DIMENSION B						
TERMINAL STYLE(E)	2 ROW	3 ROW	3 ROW 160	2 ROW W/SHIELD	3 ROW W/SHIELD	3 ROW 160 W/SHIELD
3,4	.191 [4.85]	.207 [5.25]	.220 [5.58]	.240 [5.18]	.205 [5.20]	.218 [5.53]
1,2	.124 [3.15]	.128 [3.25]	.141 [3.58]	.165 [4.18]	.126 [3.20]	.139 [3.53]

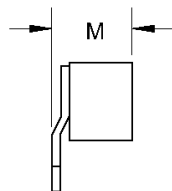

CONNECTOR W/SHIELD	M
2 ROW	.343 [8.71]
3 ROW	.447 [11.36]

HARDWARE STYLES GUIDE SOCKETS, 4 & 5 ROW HARDWARE CONFIGURATION SHOWN ASSEMBLED

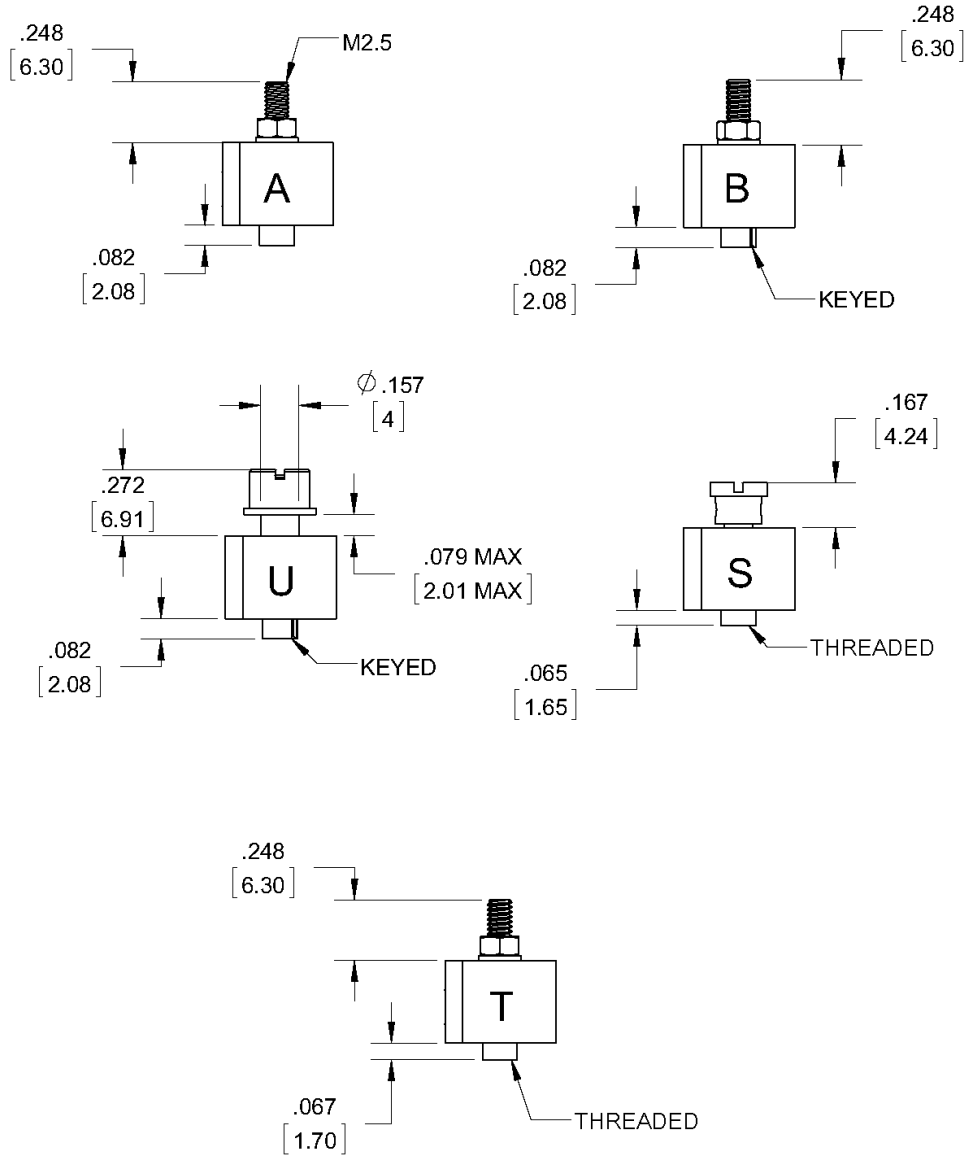

HARDWARE COMPATIBILITY									
GUIDE PINS									
	A	B	U	K	P	T	X	Y	
GUIDE SOCKETS	A	•					•		
	B		•	•				•	
	U		•	•				•	
	S				•	•	•		
	T					•			

**HARDWARE STYLES
GUIDE PINS, 4 & 5 ROW
HARDWARE CONFIGURATION SHOWN ASSEMBLED
PIN SHIELD OPTIONAL**

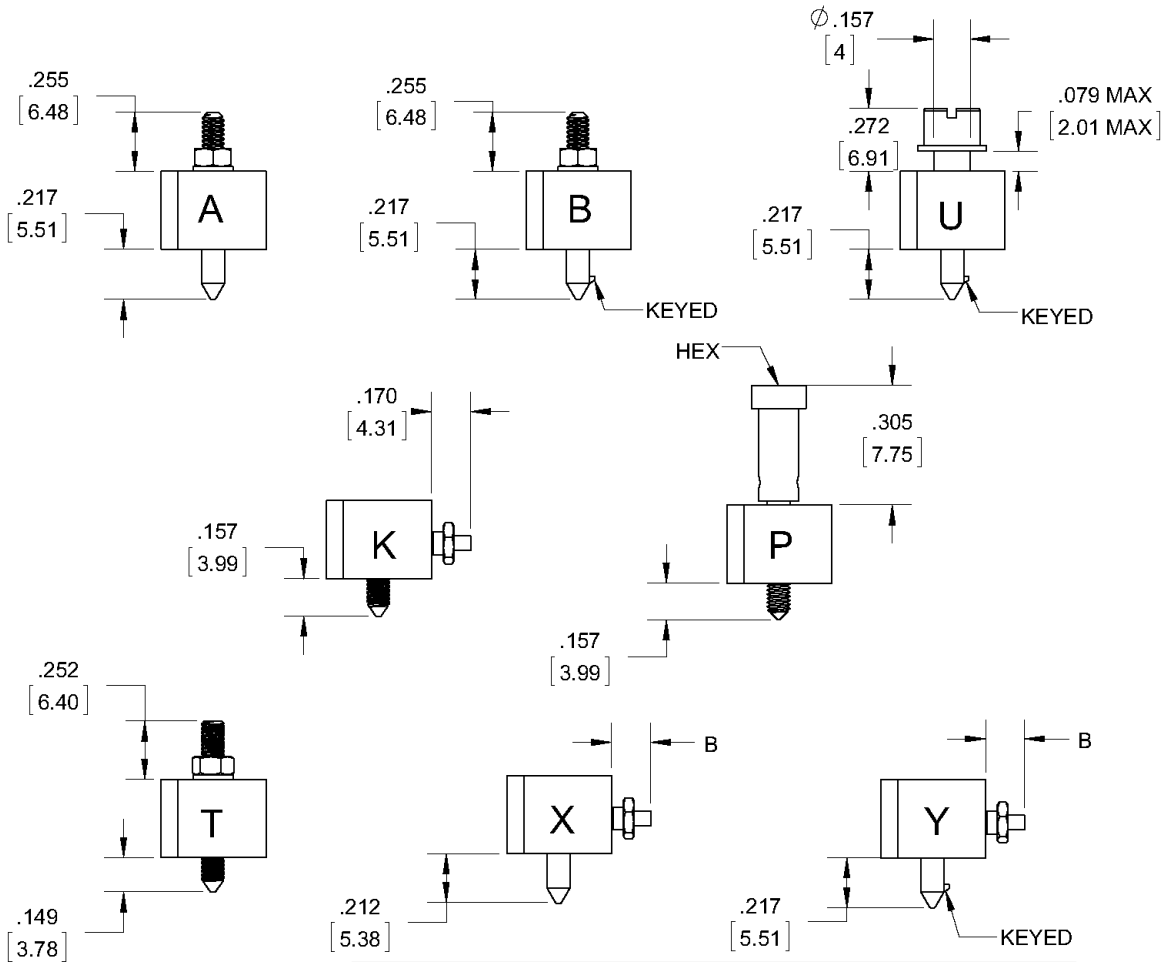

DIMENSION B				
TERMINAL STYLE (E)	4 ROW	5 ROW	4 ROW W/SHIELD	5 ROW W/SHIELD
3	.203 [5.16]	.232 [5.89]	.168 [4.26]	.236 [5.91]
2	.164 [4.16]	.153 [3.89]	.168 [4.26]	.236 [5.91]

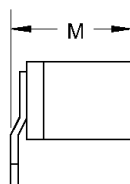

CONNECTOR W/SHIELD	M
4 ROW	.541 [13.74]
5 ROW	.661 [16.78]

PWB PATTERN 2 ROW UNINTERRUPTED, AS VIEWED FROM THE CONNECTOR SIDE

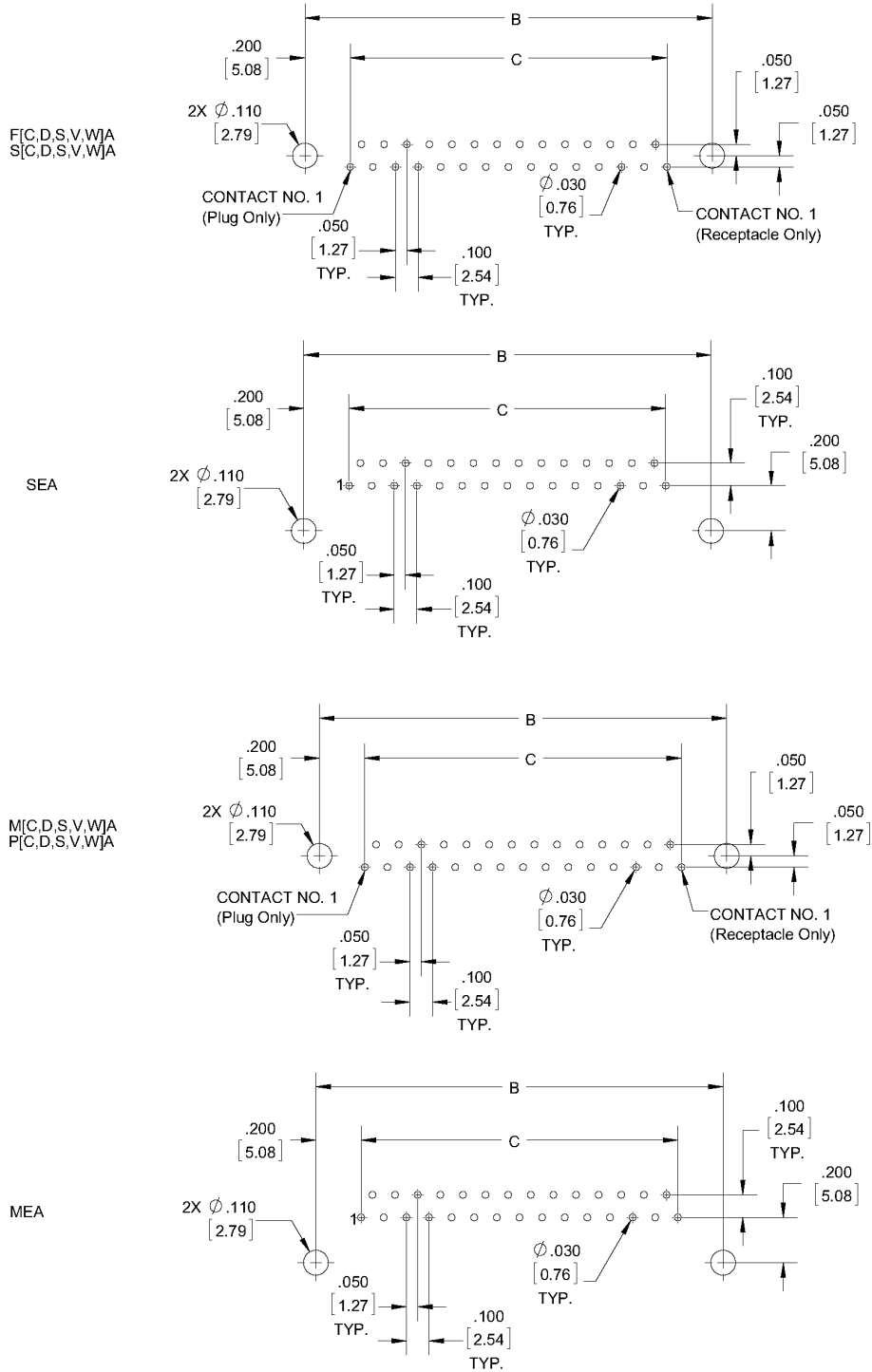

PWB PATTERN 2 ROW INTERRUPTED AS VIEWED FROM THE CONNECTOR SIDE

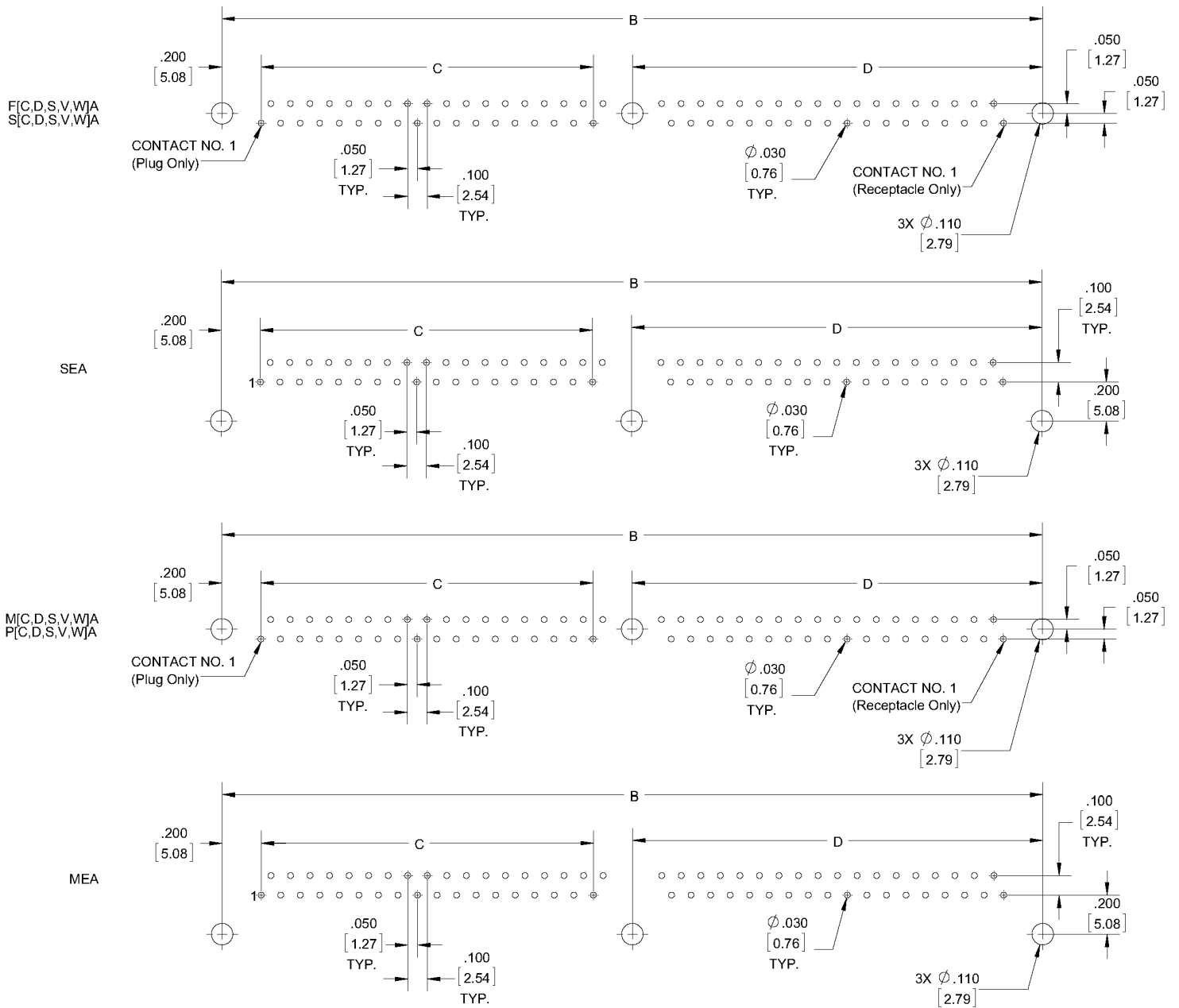

PWB PATTERN 3 ROW UNINTERRUPTED *AS VIEWED FROM THE CONNECTOR SIDE*

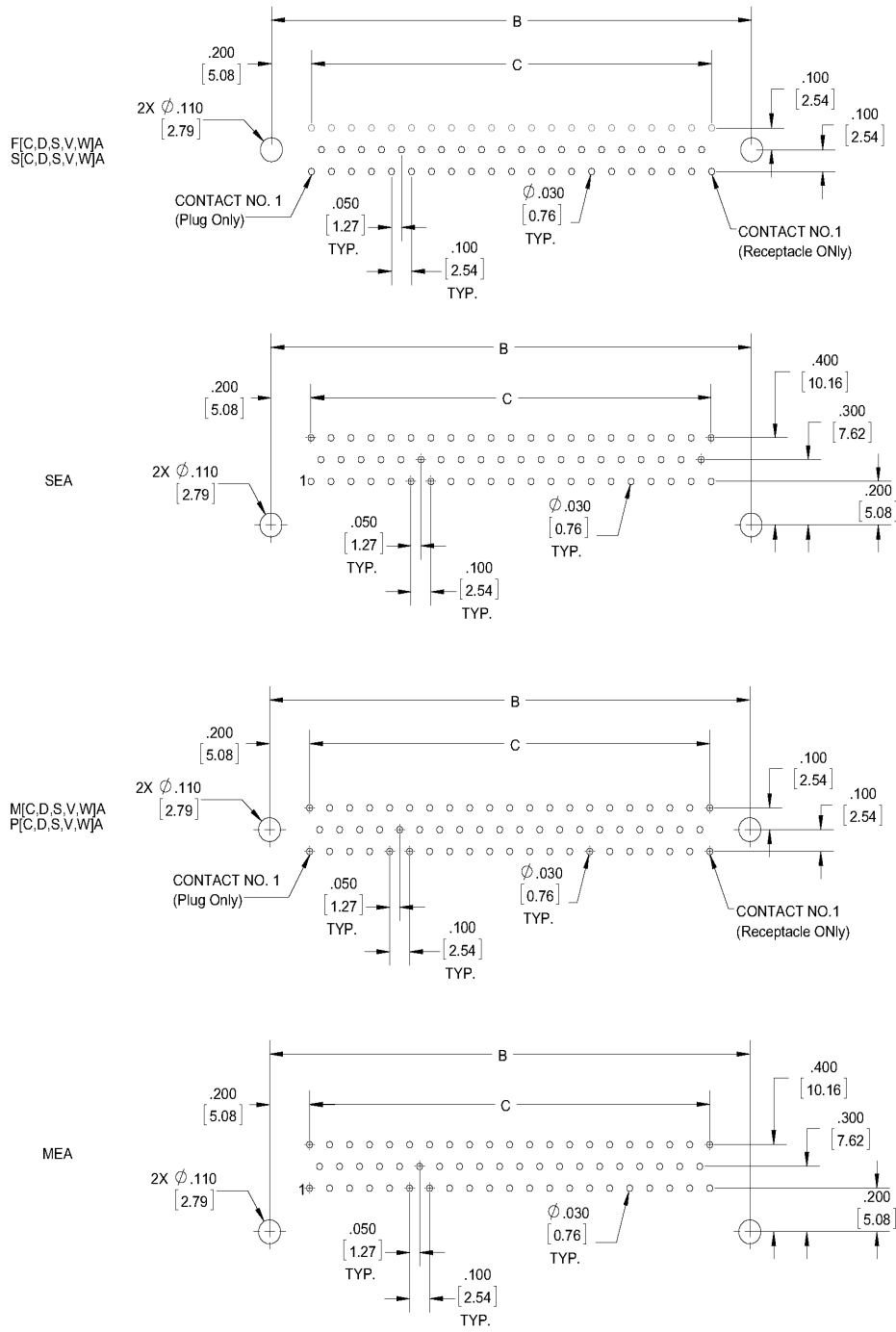

PWB PATTERN 3 ROW INTERRUPTED 126 AS VIEWED FROM THE CONNECTOR SIDE

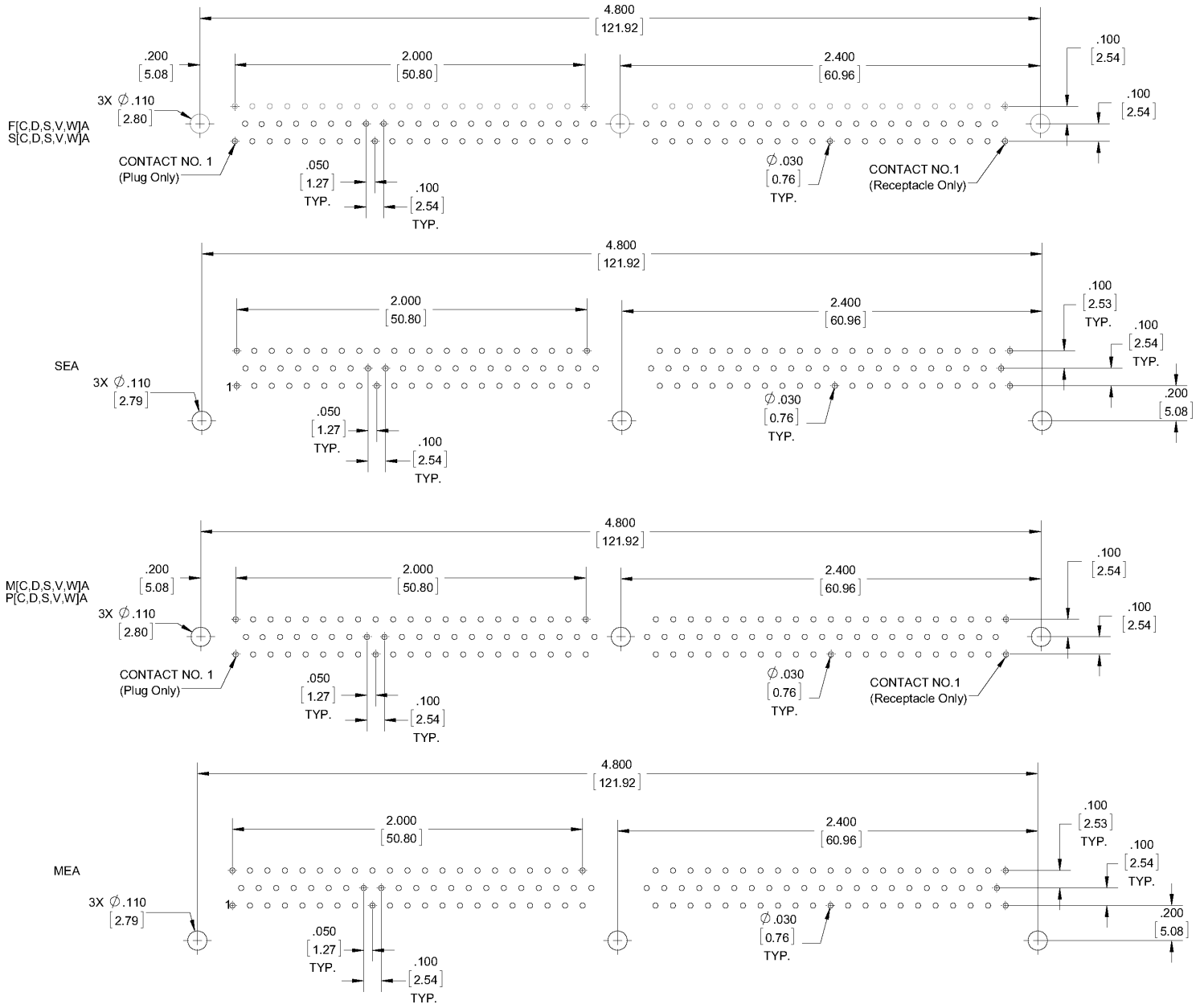

PWB PATTERN 3 ROW INTERRUPTED 160 *AS VIEWED FROM THE CONNECTOR SIDE*

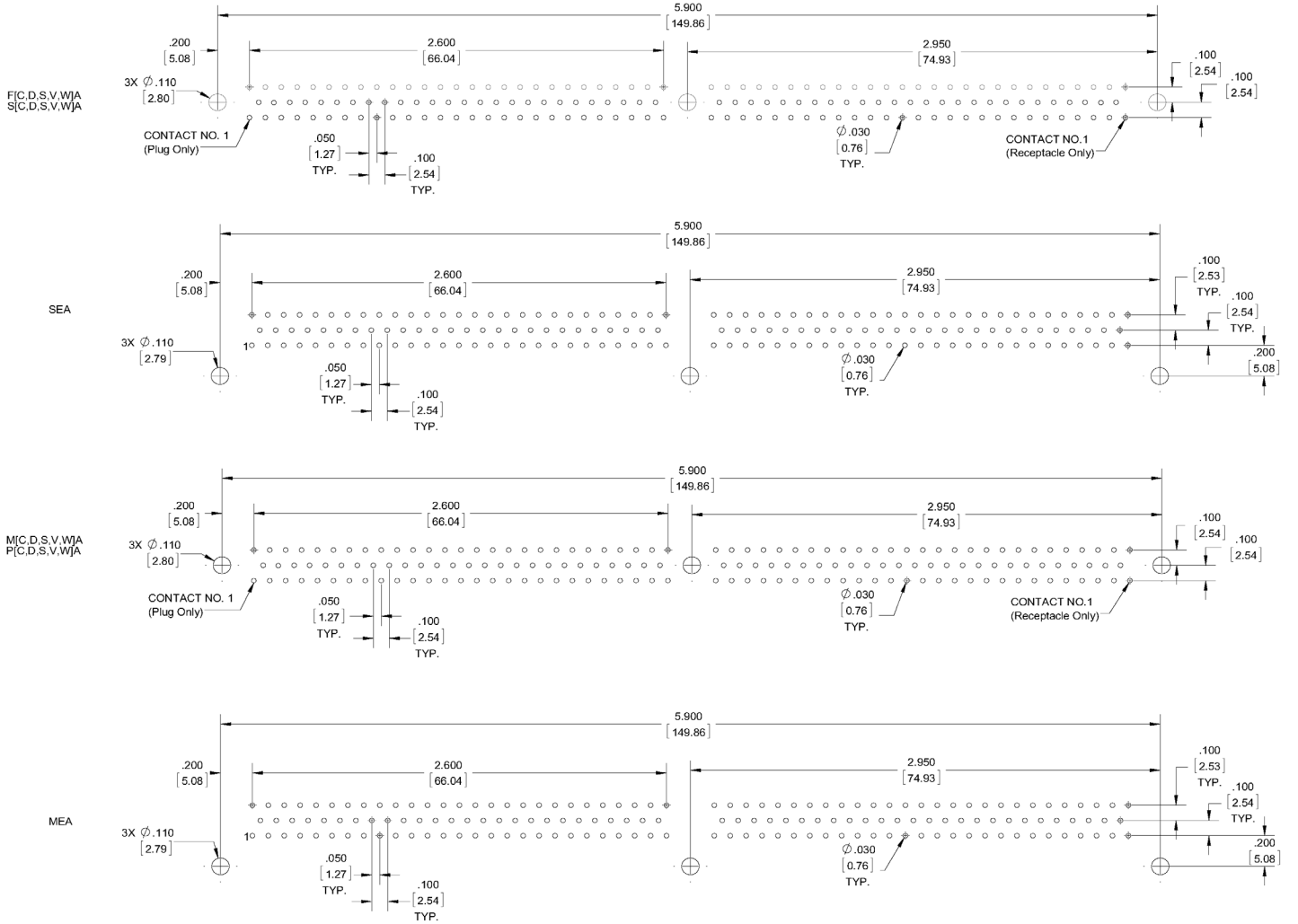

PWB PATTERN 4 ROW UNINTERRUPTED, AS VIEWED FROM THE CONNECTOR SIDE

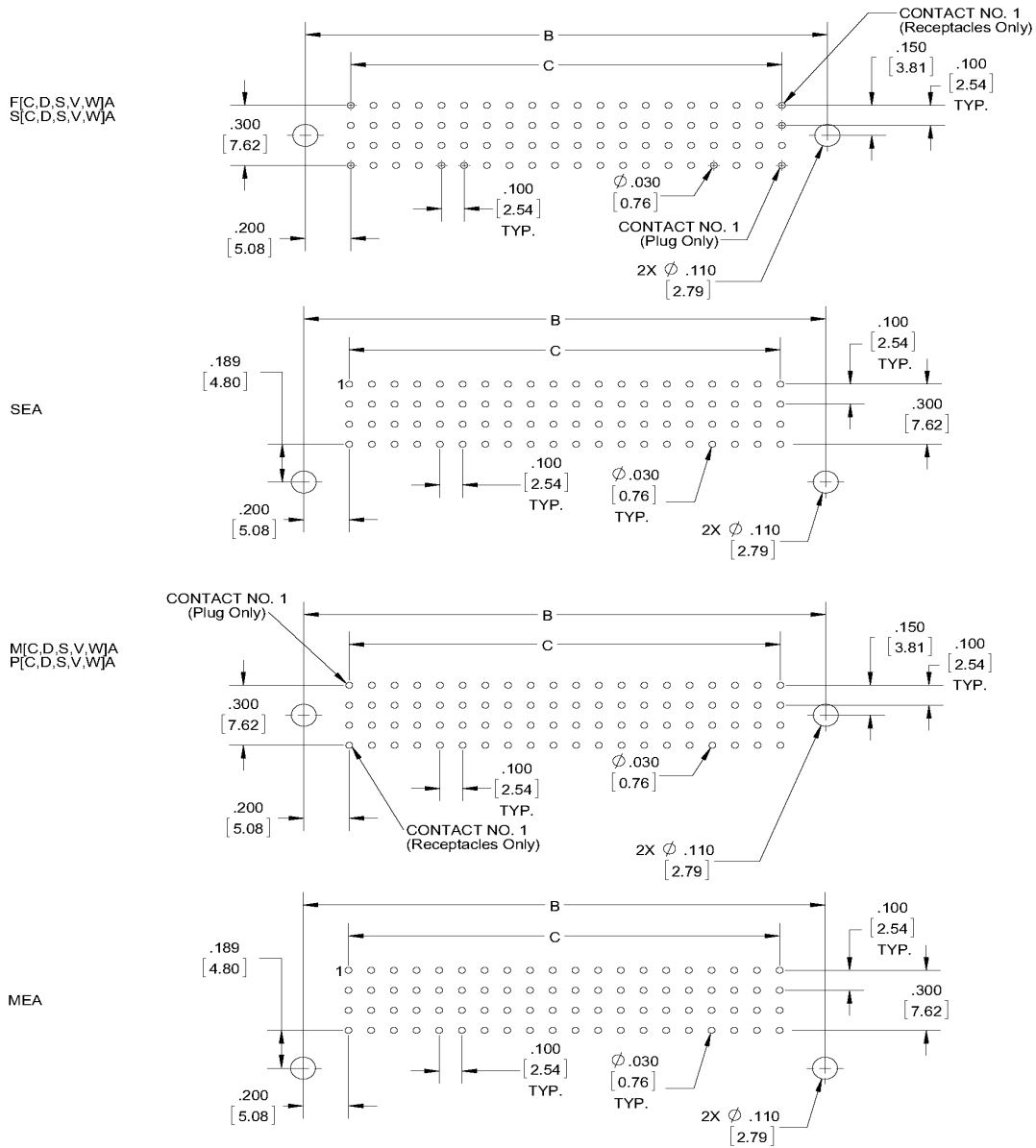

PWB PATTERN 4 ROW INTERRUPTED AS VIEWED FROM THE CONNECTOR SIDE

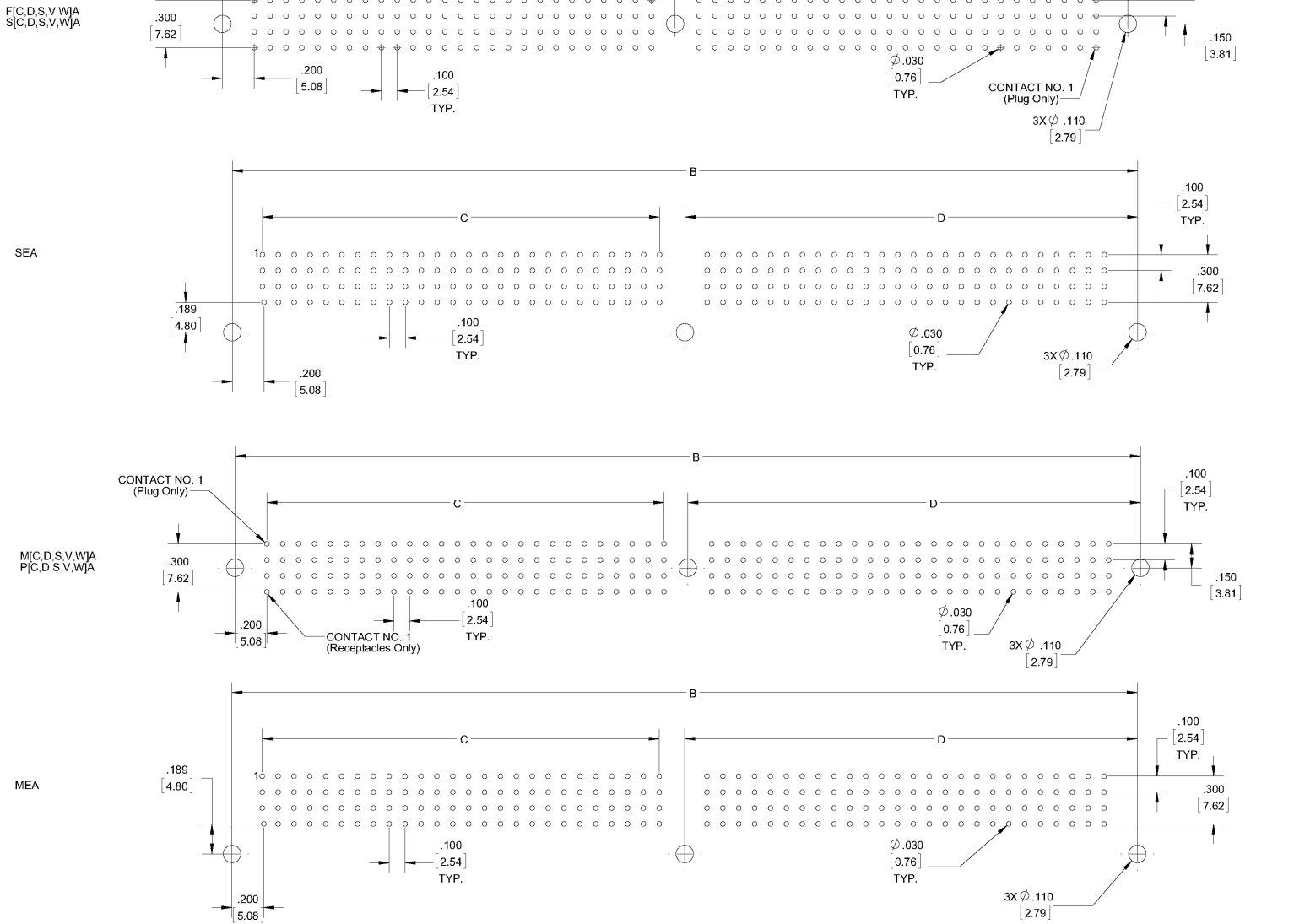

PWB PATTERN 5 ROW UNINTERRUPTED AS VIEWED FROM THE CONNECTOR SIDE

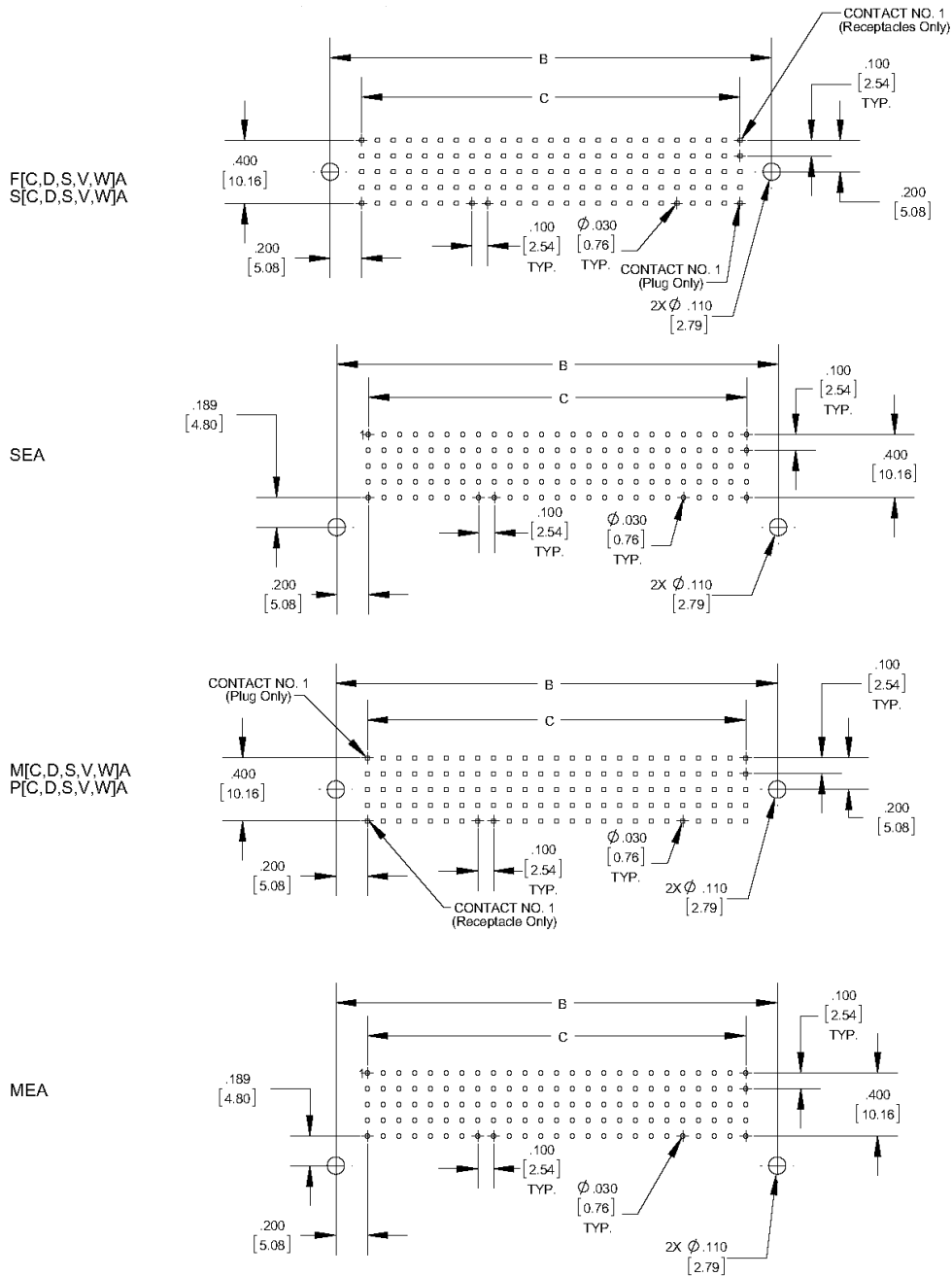

PWB PATTERN 5 ROW INTERRUPTED AS VIEWED FROM THE CONNECTOR SIDE

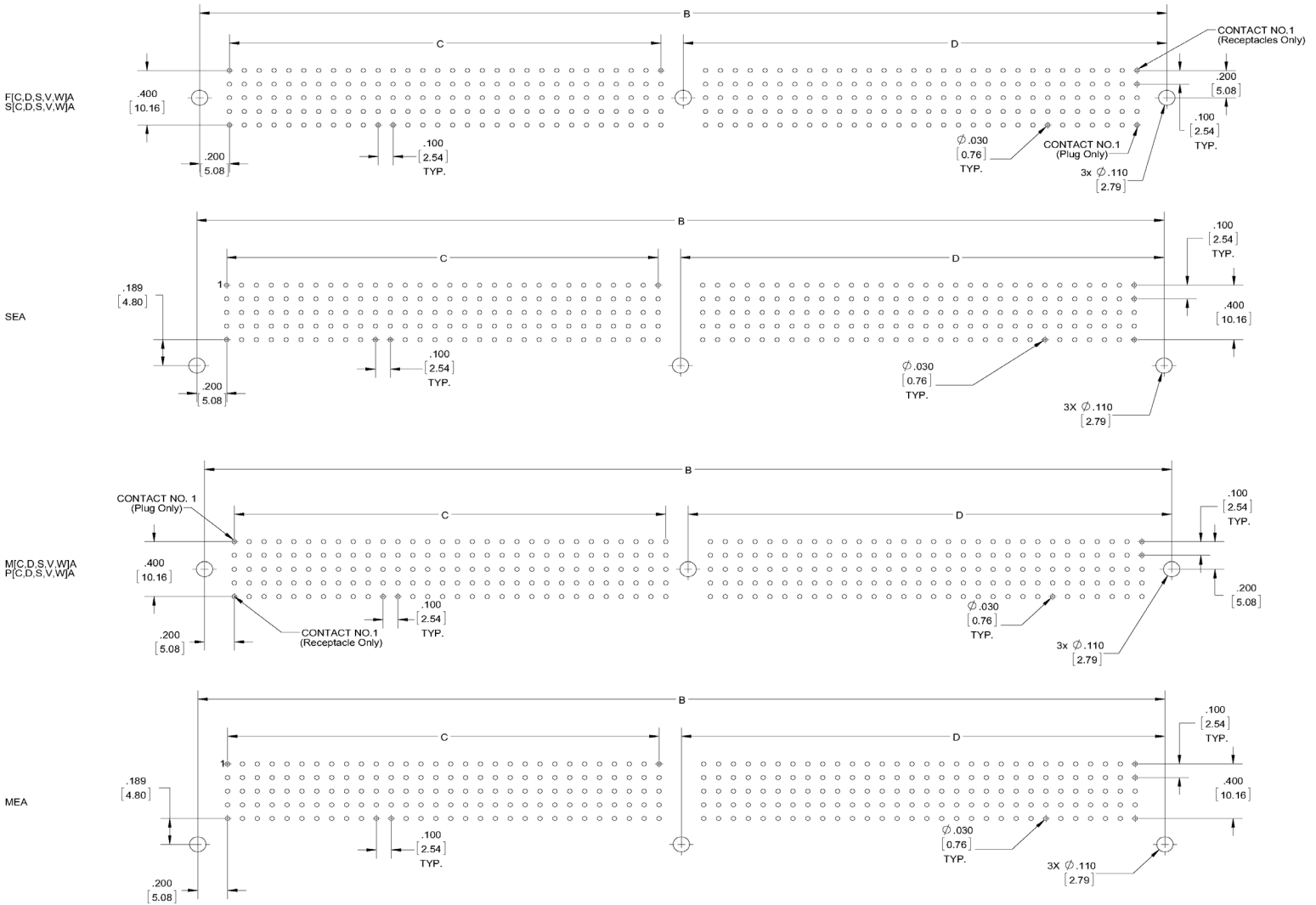

ACCESSORIES

Crimping & Tooling

OPTIONAL TOOLS

Insertion Tool:	M81969/14-01
Extraction Tool:	M81969/14-01 or S/DEM 1.0060

CRIMP TOOLS

For Termination Style C (Crimp)	
Crimp Tool Positioner	K547
Crimp Tool	M22520/2-01 or AFM8
For Termination Style G (Double Crimp)	
Crimp Tool Positioner (Wire)	K547
Crimp Tool Positioner (Insulation)	K640
Crimp Tool	M22520/2-01 or AFM8